



STR MECCANICA

Portable Multifunction Machine Tools



ENGLISH VERSION



Thank you all !!!



Sir Meccanica in the World



- Sir Meccanica S.p.A. (Headquarters and branches)
- Dealer - Service Point
- Office Point
- Up Coming Service Point

General Information

LEGAL CENTRE AND MANUFACTURING FACTORIES:

VIALE EUROPA, 37 - 88100 CATANZARO (Italy)

TEL: +39 0961 769696-769734-769672 - FAX: +39 0961-368712

Web Site: www.sirmeccanica.com

E-Mail: sirmecc@sirmeccanica.com

TAX IDENTIFICATION NUMBER: IT 01814640791

REGISTRY OF FIRMS: N° 6115 TRIBUNALE DI CATANZARO

IMPORT / EXPORT: CZ001328

CHAMBER OF COMMERCE REGISTRATION: N° 140012



Company Profile

With its over 27 year presence in the sector of systems and machine tools, Sir Meccanica has reached a prominent position in the world market for the production of portable multifunction machine tools, and is presenting new revolutionary techniques to carry out grinding work in the production and maintenance of internal and external cylindrical surfaces, in heavy and light metallic carpentry in the sectors of earthmoving, building, agriculture, road constructions, industrial field, machines and plants linked to transport and energy, railway equipment, nuclear plants, mercantile and passenger ships, gas and petroleum extracting towers, military transport vehicles and mining equipment of any brand or size, making innovation, reliability, and qualified customer service its strong points.

These sectors are as much receptive as attentive and qualified in approving Sir Meccanica's primary aims, searching for suitable solutions to their needs and always oriented towards the synergy between efficiency and economy. The product lines, created and made inside the firm's workshops are compatible and open towards the most advanced technological standards. Sir Meccanica differs from the other industrial groups operating on the market because the firm is at the disposal of its own customers as a specialized centre of skill and experience in the sector.

Thanks to technology and the ability to communicate with the customer, Sir Meccanica has already conquered the market in various continents and is striving for others in the future.

Vision

Sir Meccanica's business growth has been founded on the value of quality without any compromises.

The focused investments in technology and human resources and a steady attention to the needs and the market's demands have allowed us to develop a specialized know-how that is at our customers' complete disposal.

Expertise, technology and innovation mean higher quality of products and processes, thanks to computerized manufacturing and a steady supervision of a qualified staff.

With enthusiasm, in all these years, we have been working to offer our best in terms of quality, reliability and innovation and with the same obstinacy we are enhancing the business, by creating systems that satisfy and overcome customers' expectations.



Productive Structure

The growing market demand of qualified products has already revolutionized, in all sectors, the production and marketing concepts.



The technical evolution in the productive field and specific management procedures are basic elements for the achievement of the goals of every firm that is collocated in a global market. These concepts tied to an entrepreneurial will, have traced a continuous development within **Sir meccanica SpA** that considers quality one of the main means for success, to the point of carrying out the entire productive cycle inside the firm. This philosophy is pursued by **SIR MECCANICA SpA** with big investments in machinery plants and staff training, confirming the standardization and production concept in series, which is necessary to attain the best quality-performance/price ratio and the consequent selling success in a fast growing market.



AN IMPORTANT GROWTH

The production plant is located in the industrial area of Catanzaro (Italy), in a 4000 square metres area, equipped with the most advanced process technologies, among which welding and cutting centres and numerous CNC machines. The productive potentiality of the plant touches 1000 units per year and the result of the final product, constantly monitored by automated controls, is guaranteed by the quality of raw material that complies with the national and international laws.

The production activity and the **R&D** is developed through the commitment and cooperation of over 60 employees. All the operations, ranging from planning to production, up to delivery, are taken care of and guaranteed by the efficiency of a specialized technical staff.

The achievement of the final product is the solid result of an accurate business organization system, structured in a way that can guarantee a careful and competent administration.



Sir Meccanica, through the constant care of the details, has reached very high levels in terms of quality and safety for the final users that can benefit from reliable, safe and flawless products. We avail ourselves of the most modern and sophisticated equipment for the control of the dimensional and geometrical tolerances.

The instrumentation of the last generations and laser equipment guarantee an exact analysis of the surfaces and components. The information is gathered and transmitted to a PC which processes it through a specific software and returns the value of the analyzed tolerance, which can also be viewed graphically.



QUALITY IS A VOCATION...

... LEADERSHIP IS THE RESULT

Certifications

In order to guarantee to our market the best in terms of safety, quality and price we have decided to invest resources for the qualifications of our products and to obtain from the most prestigious certified organizations the acquisition of certifications and the protection of **international patents**.

UNI-EN-ISO 9001- 2015 Certification, states the application of rigorous procedures in the business management process.

CE certification (N° IMQ 192) states products' conformity to the safety prerequisites foreseen by communitarian directives.

GOST Certification states the conformity of Sir Meccanica's products for the exportation to Russia.

Nato Code (NCAGE AFA 74) The consolidated experience and the numerous successes reached, have permitted Sir Meccanica to obtain the Nato Code (NCAGE AFA 74), becoming an official supplier of materials and services for the Government of the United States of America and of the American bases in Europe.





Advantages

BROAD FIELD OF APPLICATION.

Sir Meccanica's machine tools are extremely versatile; they can be used on any hole that needs to be repaired. Furthermore, the fact that they are portable, enlarges their working field.

NO TRANSPORTATION COSTS.

Thanks to the portable boring machines, the equipment that needs to be repaired (even the largest machine) must no longer be transported in a specialized workshop. Our boring machines work directly on the hole that has to be repaired, in a semi-automatic way and in any position.

WORKING TIME REDUCTION.

All Sir Meccanica's products are easy to use. Once you have set the machine on the hole that needs to be repaired, it does the work in a semi-automatic way, eliminating down time.

LABOUR COSTS REDUCTION.

Our machines have an excellent price/quality ratio. Their cost is amortizable in a short time and they can be used for repair and maintenance of all industrial machines.

SAFETY AND RELIABILITY OF THE PERFORMANCES.

The machine has an electronic control panel with a diagnostic display, that allows to monitor the entire process of the performance, allowing the person that is working on the machine to intervene promptly in case of a failure or an error.



W Series

PORTABLE MULTIFUNCTION MACHINE TOOLS
For in-line boring and overlay welding.



W Series Full CNC

PORTABLE MULTIFUNCTION MACHINE TOOLS
For in-line boring and overlay welding.



Top Series

FULL CNC PORTABLE ORBITAL LATHE
For "on-site" turning with extreme precision on faces and extreme internal and/or external cylindrical surfaces, of fixed tubular bodies which are immovable or impossible to rotate.

The range

Sir Meccanica proposes a wide range of products and systems with a high added value that offer a new and revolutionary know-how applicable in all sectors of mechanics. Our machines are able to work on site, with only one simple set-up, and perform: in-line boring, internal and external overlay welding, drilling and tapping, bringing any type of ovalized or worn hole back to the original dimensions.

The products, distributed in 125 countries, are guaranteed by international patents to protect the investments made for their manufacturing, to guarantee the continuous development, to protect the final customer and to safeguard whoever operates, in the international market, for **Business to Business** and for **Business to Consumer**. They undergo a control process and a very strict final test to achieve total quality, in order to offer to the market highly reliable solutions.

Sir Meccanica's products, thanks to their versatility, simplicity and precision, are an essential tool for repairing on site holes and articulation points of big or small machines, whose disassembly would result in a machine stop and transportation to a workshop.

Sir Meccanica's portable machines allow for time saving and a considerable reduction in machining costs, as well as guaranteeing the quality of the work itself.



FMax Series

PORTABLE FLANGE FACING MACHINE TOOL

For general flange facing, milling, turning, boring, drilling (electronic dividing head for circular series) operations, creating of circular pockets, tapping, grooving, plunging, preparation of chamfers, welding, oxygen cutting.



Rotary Welding Series

PORTABLE MULTIFUNCTION MACHINE TOOLS

For overlay welding.



TMax Series

PORTABLE THREADING MACHINE TOOL

For "on-site" threading with extreme precision.



RSX9 Series

PORTABLE BORING MACHINE WITH FIXED AXLE SHAFT

The ideal solution for boring on big diameters and over long lengths.

Application Fields



Earth Moving Machine

The operations that our machines perform in this sector are multiple. Thanks to the small sizes and reduced weights, our equipment performs on-site jobs; for the first time, it is the machine tool that goes to the machinery that needs to be repaired instead of the machinery going to the workshop. Prompt and qualified assistance, availability of spare parts in a short time, total support based on customers' needs in order to offer the best assistance: these are our strong points. These benefits, added to the quality of our products, allow us to state with certainty that our offer, with our 24 months warranty, has a quality/price ratio undoubtedly convenient for our customer.



Shipyards

The shipyards represent a primary segment of our production activity. It comprises the maintenance and repair division of both civil and military ships. Our know-how has always been our company sponsor, accompanying us through the various phases of the productive process that has evolved quickly year after year, allowing us to reach excellent goals. Sir Meccanica has a complete range of machines, able to perform offshore maintenance and repair of mechanical naval systems of every kind.

A consolidated experience in mechanical carpentry of hull in the most important international shipyards, allows us to rely on high level professional staff, in this sector.



Nuclear

The evolution in the energy world market and the ever growing competitiveness among leaders involved in this sector are requiring from the companies, that want to offer suitable products and services, a constant commitment for a qualitative growth of the human and technological resources, as well as for the achievement of positive economical results. Sir Meccanica operates, in this sector with a remarkable and acknowledged success counting on high technology, high professional standards, state-of-the-art projects and a wide productive capacity. The company supplies specialized equipment for repairing and maintenance of nuclear plants. In this field, we are the ideal partner for qualified jobs. Our machines are safe, reliable and they guarantee the highest quality, they perform maintenance and repairing of thermoelectric plants and equipments, gas and oil refinery.



Industrial

A good plant maintenance is a synonym of quality and duration. To ensure a lasting and well-timed intervention, Sir Meccanica proposes its know-how, gained from a multiyear experience on the field. The company is able to satisfy the maintenance and assistance demands of any industrial plant; the company's goal is to give an opportunity to the customers to keep production plants and lines in the best possible efficient way, to delay the obsolescence with regards to quality levels and international standards, therefore obtaining a better economy of scale and a faster return for investments. All our experience is at the customers' disposal and their satisfaction is our best business card. Through the use of our portable machines, able to perform on-site, many well-timed interventions can be performed in order to limit downtime as much as possible so to re-establish operations quickly.



Railway

Sir Meccanica shows its efficiency in the maintenance and repair sector of rotating equipment, basing itself on the acquired capacity and experience, keeping pace with innovation, looking ahead towards new technologies and new goals to reach. This philosophy has helped not only to operate with growing success and to impose itself as a reality at an international level, but also to state stable and continuous relationships with buyers in the railway division at a worldwide level. The quality of the staff, the technological updates and the use of the most modern equipment, are constantly monitored by our technical office. This office relies on the cooperation of qualified employees that coordinate the different organized operations, assuring the necessary support in verifying the continuous evolutions in order to adapt them to the equipment.

Oil & Gas

Sir Meccanica has been producing equipment for maintenance and repair of thermal power equipment and oil and gas refineries, for 25 years.

The portable machine tools are designed and made in order to satisfy the needs for the maintenance of pieces hardly replaceable or removable due to their dimensions, such as valve seats, flanges and hydraulic equipment.





Series

PORTABLE MULTIFUNCTION MACHINE TOOLS

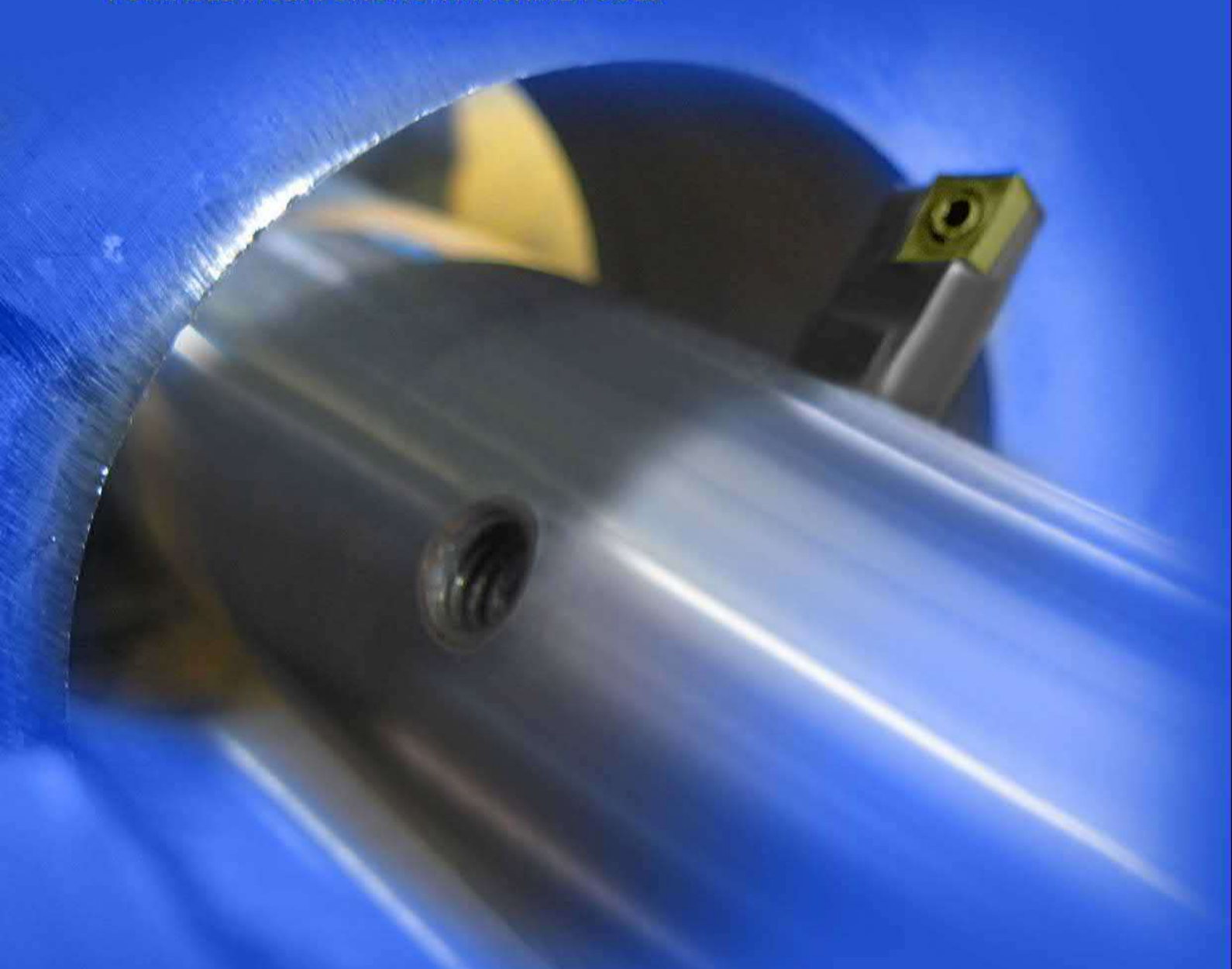

In-line boring (also on blind holes)
Overlay Welding internal and external (also on blind holes)
Drilling-Tapping-Facing Bosses
Creating Circlip Grooves – External Machining



W Smaller



W51 Plus



W52 Compact



W52 Standard



W52 Plus



W53



W55



W57 Plus



W57 Plus Triphasic

IN-LINE BORING AND OVERLAY WELDING MACHINE TOOL ...HI TECH

W Series includes 9 models. Each single machine operates on different dimensions and performs, with extreme precision, on-site repairs of holes and machinery articulated joints of big and small dimensions whose disassembly would result in a machine stop and transportation to a workshop. Statistically the use of this innovative equipment reduces of 85% the machining time.



	TOOL HOLDER SHAFT DIAMETER	BORING DIAMETER	WELDING DIAMETER	LONGITUDINAL STROKE
W Smaller	20 mm	22 mm - 70 mm	25 mm - 400 mm	UNLIMITED WITH STEP OF 120 mm
WS1 Plus	35 mm	22 mm - 180 mm	25 mm - 250 mm	UNLIMITED WITH STEP OF 120 mm
WS2 Compact	40 mm	22 mm - 400 mm	25 mm - 400 mm	UNLIMITED WITH STEP OF 110 mm
WS2 Standard	40 mm	22 mm - 400 mm	25 mm - 400 mm	UNLIMITED WITH STEP OF 210 mm
WS2 Plus	50 mm	32 mm - 450 mm	25 mm - 450 mm	UNLIMITED WITH STEP OF 210 mm
WS3	60 mm	42 mm - 800 mm	42 mm - 800 mm	UNLIMITED WITH STEP OF 250 mm
WS5	80 mm	180 mm - 1000 mm	100 mm - 1000 mm	UNLIMITED WITH STEP OF 250 mm
WS7 Plus	100 mm	400 mm - 1700 mm	400 mm - 1700 mm	UNLIMITED WITH STEP OF 250 mm
WS7 Triphasic	100 mm	400 mm - 1700 mm		UNLIMITED WITH STEP OF 300 mm

W Series: In a single, simple set-up, these machines perform on-site:

- IN LINE BORING • OVERLAY WELDING ON INSIDE AND OUTSIDE SURFACES • FACING • DRILLING • TAPPING



Drive System: The W Series is characterized by: A ROTATION DRIVE SYSTEM

“Worm gear-helical wheel”, with permanent lubrication, patented and state-of-the-art. To obtain an elevated productivity, high performance and low noise, the mechanisms are made with **16CrNi4** steel, cemented, tempered and refaced.

Particular attention has been given to the realization of the profile, to obtain a better contact among the surfaces. The wheels have a cast iron **G20** hub on which an anti-friction bronze fusion **G-CuSn12** is applied, to optimise performances and efficiency. Housing and flanges are made of engineering cast iron **G20 UNI 5007**. The commercial components used, such as tapered-roller bearings or radial ball bearings, oil seals, gaskets, lubricants are accurately selected so to guarantee high quality.

MOTORS: The power has reached elevated standards, ideal for any applicative situation which requests motion linearity, overload capacity and load control with high inertia. Magnetized and tested one by one, they guarantee reliability and efficiency.





Electronic Control Panel

An electronic circuit has been inserted to guarantee a major safety in operation and to safeguard the rotation motor from excessive strain in case of an incorrect setup of the parameters, as well as to compensate possible critical points in machining. It automatically and proportionally reduces the feeding speed to reach the maximum strain point of the rotation motor, in order to dynamically reduce the load of the work, without passing the stop point for protection.

Thanks to the led bar called **STP**, it is possible to constantly monitor the motor's work load, so to be able to optimize the choice of the parameters (rotation speed and feed speed), based on the hardness of the material, the type of tool being used, to the machining diameter and to routing diameter of the tool. Furthermore, the bar signals in advance the alarm condition and the subsequent shut down of the control panel, flashing until the working conditions are restored.

The technical characteristics include:

- AC 110 ~ 220 50/60 HZ WITH AUTOSELECTION OF MAINS VOLTAGE, WITHOUT THE USE OF TRANSFORMERS OR INVERTERS; ELIMINATING ELECTROMAGNETIC INTERFERENCES
- ESPS® TORQUE ELECTRONIC RUNNING OF THE TWO MOTORS WITH ELECTROMECHANIC SYNCHRONIZATION
- DISPLAY FOR SPEED OF ROTATION REVOLUTIONS
- ACOUSTIC WARNING WITH DISPLAY WITH FIGURED SIGNALS OF POSSIBLE FAULTS DURING THE RUNNING OF THE ROTATION MOTOR
- DISPLAY FOR SPEED OF FEEDING REVOLUTIONS
- ACOUSTIC WARNING WITH DISPLAY WITH FIGURED SIGNALS OF POSSIBLE FAULTS DURING THE RUNNING OF THE FEEDING MOTOR
- MAIN SWITCH
- EMERGENCY SWITCH
- RIGHT/LEFT INVERTER FOR FEEDING
- RIGHT/LEFT INVERTER FOR ROTATION
- POTENTIOMETER FOR ROTATION REGULATION
- POTENTIOMETER FOR FEEDING REGULATION
- SWITCH FOR RAPID TRANSLATION OF THE SHAFT





SELF-CENTRING CONNECTABLE SHAFTS WITH CONICAL COUPLING

THE CONNECTABLE SHAFTS WITH CONICAL COUPLING ARE THE RESULT OF SIR MECCANICA'S LATEST RESEARCH.

The main purpose of **Sir Meccanica's** research and development work is that of carrying on a commitment started years ago on the precision couplings and the relating resistance to stress.

More specifically, Sir Meccanica has effected studies on the locking methods of the conical couplings, used to assemble moving and fixed parts that are able to transmit elevated torsional moments or to join slender axial components, developed in length, able to resist to big torsional and bending moments.

Target:

During the production stage, particular attention has been put on maintaining the coaxiality conditions on long lengths and during high stress vibrations, in order to create a highly reliable product able to last in the course of time, even during extreme situations.

For "limited and unlimited" spaces:

Perfectly adaptable on minimum as well as immeasurable machining lengths.

The "patented" system is composed of different modules of variable size, that assembled together reach the required dimension. The system modularity makes the products and technologies with Sir Meccanica's brand even more unique.



Limited Spaces



Unlimited Spaces



TOOL HOLDERS EXTENSION WITH RAPID COUPLING

NEW AND MORE RELIABLE TOOL HOLDER SYSTEMS ARE MADE IN ORDER TO GIVE A MORE FLUID AND CONSTANT PERFORMANCE; THEREFORE REDUCING TO A MINIMUM ALL THE VIBRATIONS AND INCREASING THE PRECISION. THE DURATION OF BOTH THE MACHINE AND THE TOOL IS GUARANTEED OVER TIME.

A simple locking method increases the frictional strength on the machine shaft and it guarantees its efficiency and cutting precision.

Clutch can be dismantled and it is adjustable, it can be perfectly fastened on both sides in order to obtain an optimal locking and to eliminate tolerance errors and mechanical wear.

Stable axial, radial, and angular positionings on the entire surface of the machine shaft for any type of working configuration.

Rapid blocking and unblocking, it eliminates the risk of having possible misalignments in the working area during the change and the positioning phase of the tool, and it considerably improves the safety conditions for the users that operate manually in dangerous working spaces.



**TOOL HOLDER
EXTENSION**
Quick action

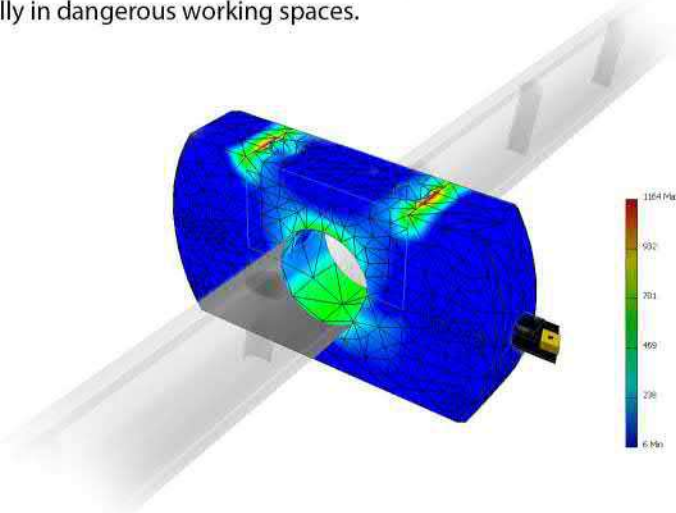



SMALLER

In-Line Boring and Overlay Welding Machine Tool ...hi Tech

The machines perform, with one single and simple set-up, on-site work for:

- In-Line Boring
- Internal and external Overlay Welding



Technical Characteristics

BORING DIAMETER	WELDING DIAMETER	WELDING TECHNOLOGY
22 mm - 70 mm	25 mm - 400 mm	SPIRAL (CONTINUOUS WITH VARIABLE STEP)
LONGITUDINAL STROKE	TOOL HOLDER SHAFT DIAMETER	TOOL HOLDER SHAFT LENGTH
UNLIMITED WITH STEP OF 120 mm	20 mm	2 connectable self-centring bars with conical coupling 1000+1000 mm
DRIVE UNIT WEIGHT		
12 Kg		





SR
MECCANICA

Fabbrica Italiana Macchine Utensili Portatili Multifunzione

W51 Plus

In-Line Boring and Overlay Welding Machine Tool ...hi Tech

The machines perform, with one single and simple set-up, on-site work for:

- In-Line Boring
- Internal and external Overlay Welding



Technical Characteristics

BORING DIAMETER	WELDING DIAMETER	WELDING TECHNOLOGY
22 mm - 180 mm	25 mm - 250 mm	SPIRAL (CONTINUOUS WITH VARIABLE STEP)
LONGITUDINAL STROKE	TOOL HOLDER SHAFT DIAMETER	TOOL HOLDER SHAFT LENGTH
UNLIMITED WITH STEP OF 120 mm	35 mm	3 connectable self-centring bars with conical coupling 1000+1000+500 mm
DRIVE UNIT WEIGHT		
20 Kg		





SR
MECCANICA

Fabbrica Italiana Macchine Utensili Portatili Multifunzione

W52 Compact

In-Line Boring and Overlay Welding Machine Tool ...hi Tech

The machines perform, with one single and simple set-up, on-site work for:

- In-Line Boring
- Internal and external Overlay Welding
- Drilling
- Tapping



Technical Characteristics

BORING DIAMETER	WELDING DIAMETER	WELDING TECHNOLOGY
22 mm - 400 mm	25 mm - 400 mm	SPIRAL (CONTINUOUS WITH VARIABLE STEP)
LONGITUDINAL STROKE	TOOL HOLDER SHAFT DIAMETER	TOOL HOLDER SHAFT LENGTH
UNLIMITED WITH STEP OF 110 mm	40 mm	3 connectable self-centring bars with conical coupling 1000+1000+730 mm
DRIVE UNIT WEIGHT		
27 Kg		





SR
MECCANICA

Fabbrica Italiana Macchine Utensili Portatili Multifunzione



In-Line Boring and Overlay Welding Machine Tool ...hi Tech

The machines perform, with one single and simple set-up, on-site work for:

- In-Line Boring
- Internal and external Overlay Welding
- Drilling
- Tapping



Technical Characteristics

BORING DIAMETER	WELDING DIAMETER	WELDING TECHNOLOGY
22 mm - 400 mm	25 mm - 400 mm	SPIRAL (CONTINUOUS WITH VARIABLE STEP)
LONGITUDINAL STROKE	TOOL HOLDER SHAFT DIAMETER	TOOL HOLDER SHAFT LENGTH
UNLIMITED WITH STEP OF 210 mm	40 mm	3 connectable self-centring bars with conical coupling 1000+1000+730 mm
DRIVE UNIT WEIGHT		
34 Kg		





SR
MECCANICA

Fabbrica Italiana Macchine Utensili Portatili Multifunzione

WS2 Plus

In-Line Boring and Overlay Welding Machine Tool ...hi Tech

The machines perform, with one single and simple set-up, on-site work for:

- In-Line Boring
- Internal and external Overlay Welding
- Drilling
- Tapping



Technical Characteristics

BORING DIAMETER	WELDING DIAMETER	WELDING TECHNOLOGY
32 mm - 450 mm	25 mm - 450 mm	SPIRAL (CONTINUOUS WITH VARIABLE STEP)
LONGITUDINAL STROKE	TOOL HOLDER SHAFT DIAMETER	TOOL HOLDER SHAFT LENGTH
UNLIMITED WITH STEP OF 210 mm	50 mm	3 connectable self-centring bars with conical coupling 1000+1000+860 mm
DRIVE UNIT WEIGHT		
35 Kg		





SIR
MECCANICA

Fabbrica Italiana Macchine Utensili Portatili Multifunzione



In-Line Boring and Overlay Welding Machine Tool ...hi Tech

The machines perform, with one single and simple set-up, on-site work for:

- In-Line Boring
- Internal and external Overlay Welding
- Drilling
- Tapping



Technical Characteristics

BORING DIAMETER	WELDING DIAMETER	WELDING TECHNOLOGY
42 mm - 800 mm	42 mm - 800 mm	SPIRAL (CONTINUOUS WITH VARIABLE STEP)
LONGITUDINAL STROKE	TOOL HOLDER SHAFT DIAMETER	TOOL HOLDER SHAFT LENGTH
UNLIMITED WITH STEP OF 250 mm	60 mm	3 connectable self-centring bars with conical coupling 1500+1600+1600 mm
DRIVE UNIT WEIGHT		
50 Kg		





SIR
MECCANICA

Fabbrica Italiana Macchine Utensili Portatili Multifunzione



In-Line Boring and Overlay Welding Machine Tool ...hi Tech

The machines perform, with one single and simple set-up, on-site work for:

- In-Line Boring
- Internal and external Overlay Welding



Technical Characteristics

BORING DIAMETER	WELDING DIAMETER	WELDING TECHNOLOGY
180 mm - 1000 mm	100 mm - 1000 mm	SPIRAL (CONTINUOUS WITH VARIABLE STEP)
LONGITUDINAL STROKE	TOOL HOLDER SHAFT DIAMETER	TOOL HOLDER SHAFT LENGTH
UNLIMITED WITH STEP OF 250 mm	80 mm	2 connectable self-centring bars with conical coupling 2000 + 1135 mm
DRIVE UNIT WEIGHT		
65 Kg		



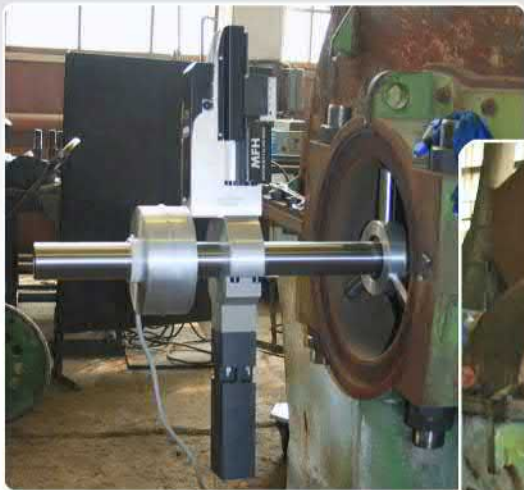

SIR
MECCANICA

Fabbrica Italiana Macchine Utensili Portatili Multifunzione

W57 Plus

In-Line Boring and Overlay Welding Machine Tool ...hi Tech

The machines perform, with one single and simple set-up, on-site work for:

- In-Line Boring
- Internal and external Overlay Welding



Technical Characteristics

BORING DIAMETER	WELDING DIAMETER	WELDING TECHNOLOGY
400 mm - 1700 mm	400 mm - 1700 mm	SPIRAL (CONTINUOUS WITH VARIABLE STEP)
LONGITUDINAL STROKE	TOOL HOLDER SHAFT DIAMETER	TOOL HOLDER SHAFT LENGTH
UNLIMITED WITH STEP OF 250 mm	100 mm	2 connectable self-centring bars with conical coupling 2000 + 1135 mm
DRIVE UNIT WEIGHT		
105 Kg		





SIR
MECCANICA

Fabbrica Italiana Macchine Utensili Portatili Multifunzione

W57 Plus TRIPHASIC

In-Line Boring Machine Tool ...hi Tech

The machines perform, with one single and simple set-up, on-site work for:

- In-Line Boring



Technical Characteristics

BORING DIAMETER	LONGITUDINAL STROKE	MAX ROTATION SPEED
400 mm - 1700 mm	UNLIMITED WITH STEP OF 300 mm	35.75 Rpm
MAX FEED SPEED (RAPID BUTTON)	REMOVAL MATERIAL	TOOL HOLDER SHAFT DIAMETER
25.4 mm/min	173 cm ³ /min	100 mm
TOOL HOLDER SHAFT LENGTH	DRIVE UNIT WEIGHT	
2 connectable self-centring bars with conical coupling 2000 + 1135 mm	160 Kg	





SR
MECCANICA

Fabbrica Italiana Macchine Utensili Portatili Multifunzione



ACCESSORIES

Accessories and kits to add on each single machine,
in order to enhance or modify the operation possibilities.

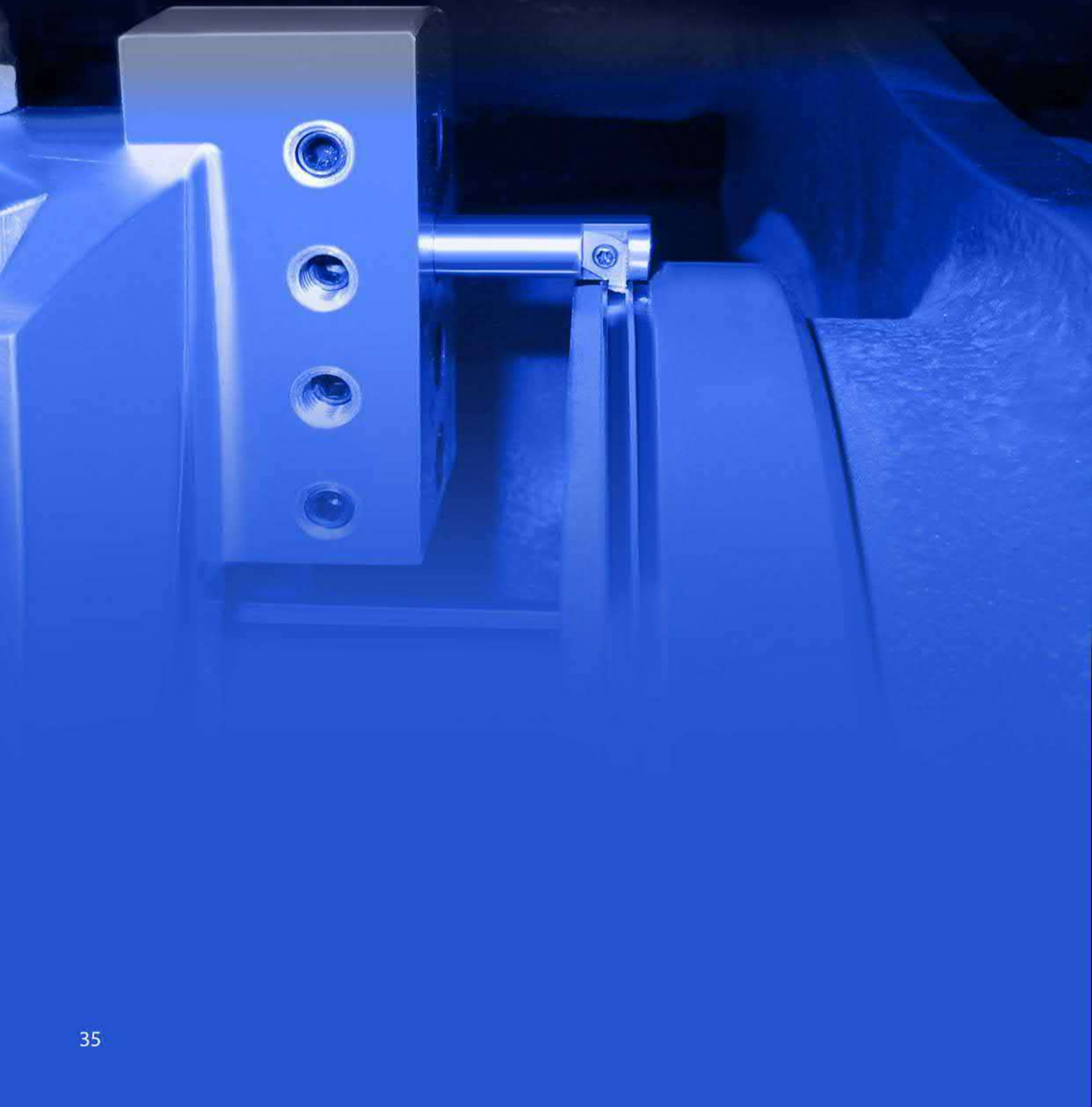



• Kit 2000 Facing Head



• MFH Motorized Facing Head:



• Electronic Positioning / Display Screen



• Kew Kit for External Turning



• Internal Supports

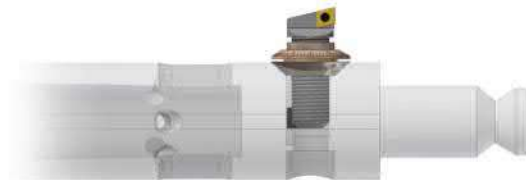

• Adjustable Tool Holder with Micrometric Precision



Kit 2000 Facing Head

TOOLHOLDER HEAD FOR BORING AND FACING WITH RADIAL SEMI-AUTOMATIC FEED.

Designed for the WS Series Portable Boring Machine Tools. Proposed in various models of small, medium and large dimensions. Presents a high precision modular toolholder system for machining on various diameter ranges.

The **Kit 2000**, is installed on the rotating axis of the machine tool, through a simple screw locking and without any interface.



This kit, evolving in the course of time in various models, with more refined, precise and balanced movements assures a major duration of the insert, a suitable cutting speed and the achievement of good surface finishing.

- **FACING BOSSES**
- **SEGER AND O-RING HOUSING**
- **EXTERNAL MACHINING**
- **CIRCULAR POCKETS**

Actuator for Remote Operation for Kit 2000

Through this mechanical device, it is possible to comfortably manage at a distance and in safety the "feed wheel" of the "**Kit 2000**" allowing the operator to carry out and check the various stages of machining from any position and angle.

Once installed, it acts as an actuator for the transmission of the radial forward motion of the tool;

the system is activated through a **MODULAR COMMAND LEVER**". This system is equipped, inside, with a safety device that in case of jam or excessive strain of the tool, during the machining stage, it puts the transmission in neutral.

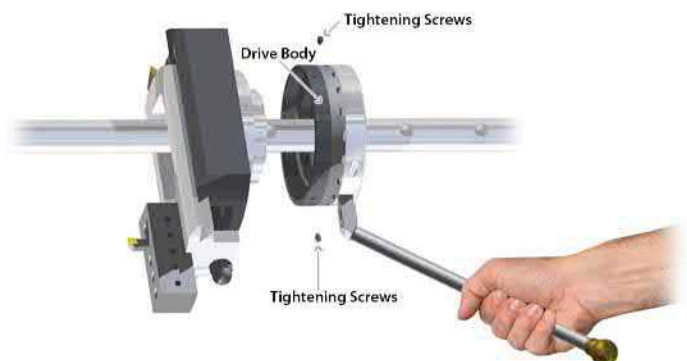

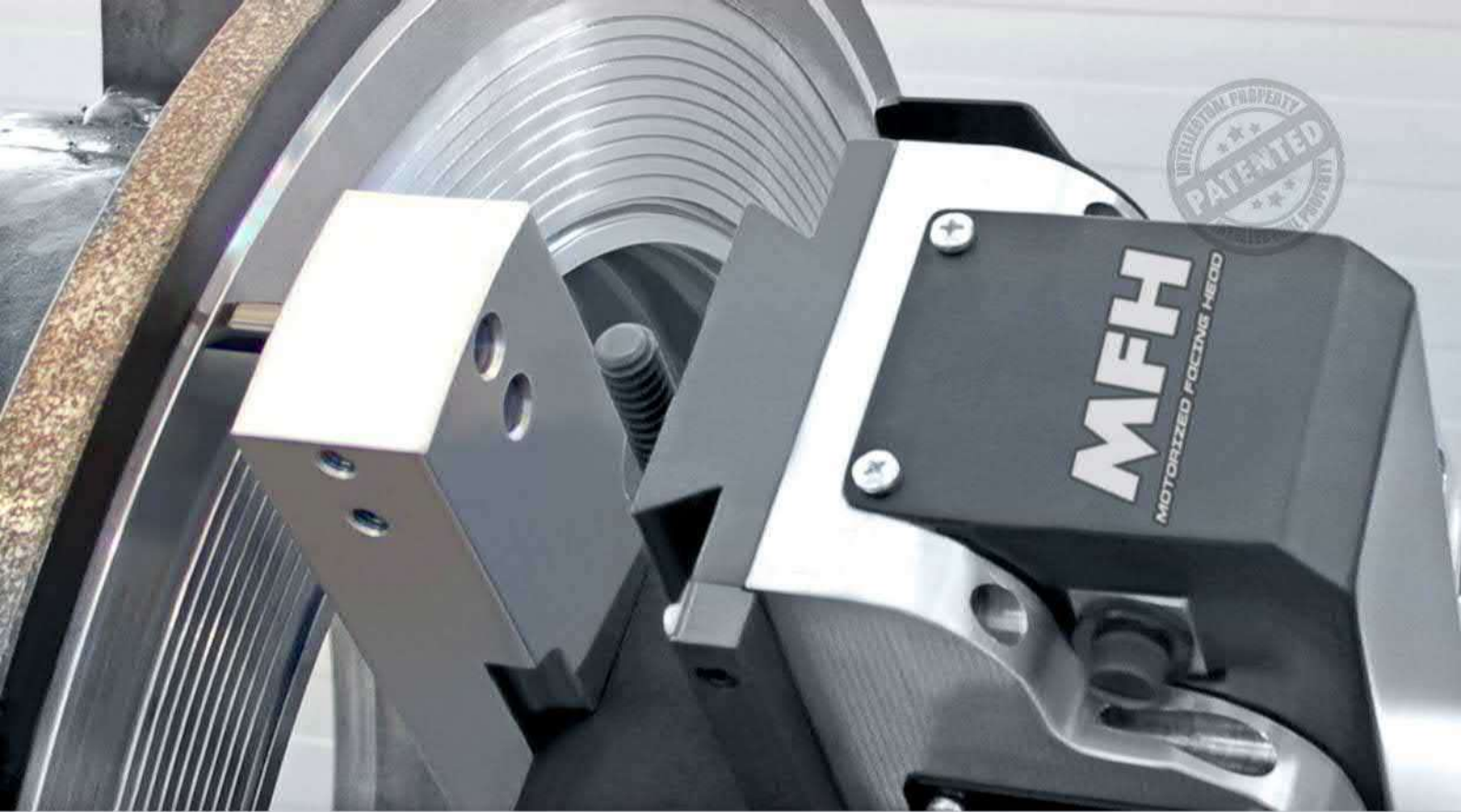

MFH Motorized Facing Head:

The motorized facing head, held on an rotating and translating axis, managed by the WS machines, is used to do facing jobs or internal turning jobs (linear or non linear) on tubular cylindrical bodies, allowing the operator to control all the steps of the machining through an electronic control panel.

- **FACING BOSSES**
- **SEGER AND O-RING HOUSING**
- **INTERNAL TURNING JOBS** (linear and non linear)
- **CONCENTRIC GROOVES**
- **EXTERNAL MACHINING**

The system is controlled by a control panel that is different from the main one. The system is electronically powered, in an autonomous and separate way.

The power supply is managed through a rotating collector, positioned on the shaft next to the head.



MFH WS2 Plus

MINIMUM WORKING DIAMETER	70 mm
MAXIMUM WORKING DIAMETER	450 mm
STROKE WITH STEP FROM	80 mm



MFH WS3 Normal | MFH WS3 Mini

MINIMUM WORKING DIAMETER	80 mm	80 mm
MAXIMUM WORKING DIAMETER	800 mm	600 mm
STROKE WITH STEP FROM	130 mm	80 mm



MFH WS5

MINIMUM WORKING DIAMETER	100 mm
MAXIMUM WORKING DIAMETER	1000 mm
STROKE WITH STEP FROM	240 mm



MFH WS7 Plus | MFH WS7 Plus Mini

MINIMUM WORKING DIAMETER	120 mm	145 mm
MAXIMUM WORKING DIAMETER	1700 mm	800 mm
STROKE WITH STEP FROM	240 mm	90 mm



Kit 2000 Motorized

MINIMUM WORKING DIAMETER	Customized
MAXIMUM WORKING DIAMETER	Customized
STROKE WITH STEP FROM	Customized



ELECTRONIC POSITIONING / DISPLAY SCREEN

INNOVATIVE DEVICE, SAFE AND EXTREMELY PRECISE, THE POSITIONING/DISPLAY REPRESENTS THE NEW FRONTIER OF TECHNOLOGICAL INNOVATION REACHED BY SIR MECCANICA

This equipment can display, in real time, not only the space covered by the tool in relation to a defined initial point, but also the exact quote that the tool has to reach during the working/movement phase.

Besides the current position of the tool and the information regarding the distance to be covered during machining, the display offers the possibility to view the data relating to the feed speed (mm/min) and the **STATUS** of the work (positioner/display). Reliable and Precise (hundredth of millimeter), this device facilitates, or rather eliminates the operator's manipulation during the complex phases of measuring and consequent **"stop and go"**.

The electronic part of this equipment, harmoniously contained inside the control panel, has a state-of-the-art hardware-software system that makes the product innovative and dynamic.

In addition to ensuring a considerable reduction of processing times, the high versatility and the immediacy of the viewer using the **electronic positioner** ensure greater efficiency and accuracy.

Posizionatore - Positioner - Positionneur - Posicionador

ACTUAL POSITION | REMAINING | SPEED | ST
 000 | 000 | 000/MIN |

General technical characteristics :

Multilanguage : Italian, Spanish, French, English, German, Russian

LCD Display : Backlighted, 40 characters for 2 lines

Functioning : Insertable and disconnectable while working

Reading : Through magnetic encoder with quadrature signal

Interface : Two keys for the use and setting of all the features



Internal Supports

SIMPLE, BRILLIANT AND INNOVATIVE SYSTEMS THAT ALLOW FOR EXTREMELY PRECISE MACHINING EVEN ON INDEFINITE LENGTHS.



Internal Fixed Support

Internal support that can be assembled with modular legs of different sizes. Each leg can be adjusted in an independent way in order to facilitate the centering even on surfaces that are not perfectly circular. This support can be immediately installed and if coupled serially, is very useful in machining of coaxial hinges that are positioned one after the other.



Centering Ring and internal Support

The Centering ring has been designed to be used inside tubular bodies. The four punches are independently adjustable, and they allow an easy and fast centering operation on the tool holder shaft. It guarantees the maximum precision even in cases where the centering needs to be performed on surfaces that are not perfectly circular, allowing to position the tool holder shaft along the axis of the piece that needs to be machined. It is available for all W series machine tools, in different sizes according to specific customer requests.



Self-Centering Sliding Support with Pneumatic Expansion

The self-centering support slides together with the tool and the shaft that rotates inside of it. It follows the tool, and therefore slides on a well machined and refined circular surface. The 3 legs expand simultaneously with the use of compressed air. It follows the tool for the whole machining stage. Positioned right after the tool, it works as a shock absorber to damp cutting vibrations. As it self-centers on well refined surfaces, it constantly maintains the shaft on the axis. It guarantees the maximum precision in any conditions and in any length.

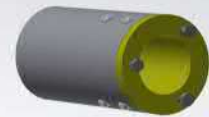

Internal Self Centering Support

The tightening of the screw through the appropriate "spark plug wrench" supplied with the bearing housing, allows you to position and fasten such bearing housing inside the pipe that needs machining. Its compact design, allows the bearing housing to be installed inside pipes that have small diameter dimensions.

By self centering on well finished surfaces, it guarantees an optimal centering by keeping the shaft constantly aligned with the axis.



Fixed Mechanical Centering Support

By acting on the appropriate screws with the "long swivel wrench", supplied with the standard equipment, it is possible to move each single leg in order to regulate the expansion at a distance. It can be used inside deep and inaccessible cylindrical cavities. Perfect for centering on surfaces that are not perfectly circular.



KEW KIT FOR EXTERNAL TURNING

Structure with multiple degrees of freedom that, framed onto the body to be machined, permits the set up of the W Machine tool that will carry out the external turning operation.

The kit, thanks to its swivels and adjustable elements, allows for a perfect centring of the machine on the cylindrical body. This structure is equipped with systems for rough and fine adjustment, which are necessary in order to reach the required geometric tolerances.

Multiple Operations:



External Overlay welding



External Turning



Conical Machining



ADJUSTABLE TOOL HOLDER WITH MICROMETRIC PRECISION

It is possible to move the insert from one side to the other through the rotation of the "GRADABLE LEADSCREW"

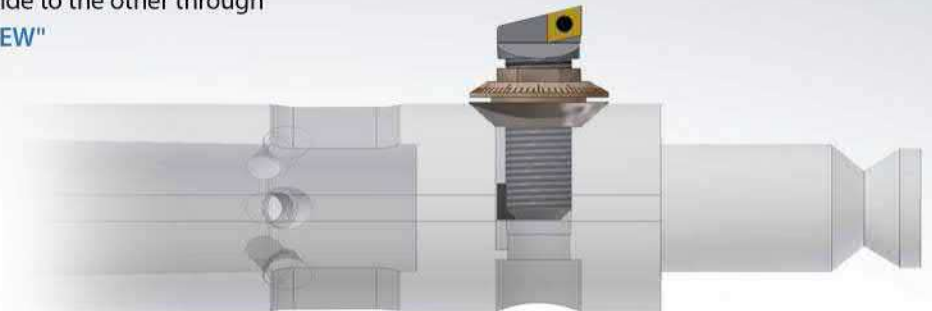

Adjustable radial positioning with **EXTREME PRECISION**



For each type of "EXTENSION" and any eventual "TOOL HOLDER BAR" (see WS manual), it is possible, upon request, to have the equivalent variation for "ADJUSTABLE TOOL HOLDERS".



Series

FULL CNC

PORTABLE MULTIFUNCTION MACHINE TOOLS



It is unique of its kind, it has all the advantages of the W Series machine tools, enhanced with a CNC head, that allows to perform the following machining operations.

- Curved shaping,
- Conical machining and any type of chamfer
- All types of threadings - Simple and shaped facing
- Any type of grooving - Phonographic grooves



WS3 FULL CNC



Dragster 600



Dragster 800



Dragster 1000

WS5 and WS7 Full CNC
COMING SOON



TOUCH SCREEN DISPLAY

The CNC interface is simple and intuitive. Besides the possibility to create programs manually, it is also possible to execute files created by sophisticated CAM programs without having to key in any command.

The three modalities **FILE, JOG e MDI** are fully supported and can be used together. It is possible to open a file and view it, give commands in **MDI modality** and pass onto the **JOG modality** without any limits.

WS3 Series FULL CNC

In-Line Boring and Overlay Welding Machine Tool ...hi Tech

The machine allows you to manage all the boring and CNC precise turning operations:

- Curved shaping with any tips of radius
- Conical machining and any type of chamfer
- All types of threadings
- Simple and shaped facing
- Any type of grooving
- Phonographic grooves



Technical Characteristic

WORKING DIAMETER	AXIAL STROKE (Z)	RADIAL STROKE (X)
110 mm - 600 mm	250 mm	It depends on the chosen model of machining head
3 DEGREE OF FREEDOM	2 AXIS	DRIVE UNIT WEIGHT
(X - Z - S)	(X - Z)	72,5 Kg

CUSTOMIZABLE according to customer's needs

Upon request the machine can also be supplied with the standard equipment to perform all the jobs carried by the **W Series, including the Overlay Welding**





dragster 600

FULL CNC

In-Line Boring and Overlay Welding Machine Tool ...hi Tech

The machine allows you to manage all the boring and CNC precise turning operations:

- Curved shaping with any tips of radius
- Conical machining and any type of chamfer
- All types of threadings
- Simple and shaped facing
- Any type of grooving
- Phonographic grooves



Technical Characteristic

WORKING DIAMETER	AXIAL STROKE (Z)	RADIAL STROKE (X)
110 mm - 600 mm	600 mm	It depends on the chosen model of machining head
3 DEGREE OF FREEDOM	2 AXIS	DRIVE UNIT WEIGHT
(X - Z - S)	(X - Z)	95 Kg

CUSTOMIZABLE according to customer's needs

Upon request the machine can also be supplied with the standard equipment to perform all the jobs carried by the **W Series, including the Overlay Welding**

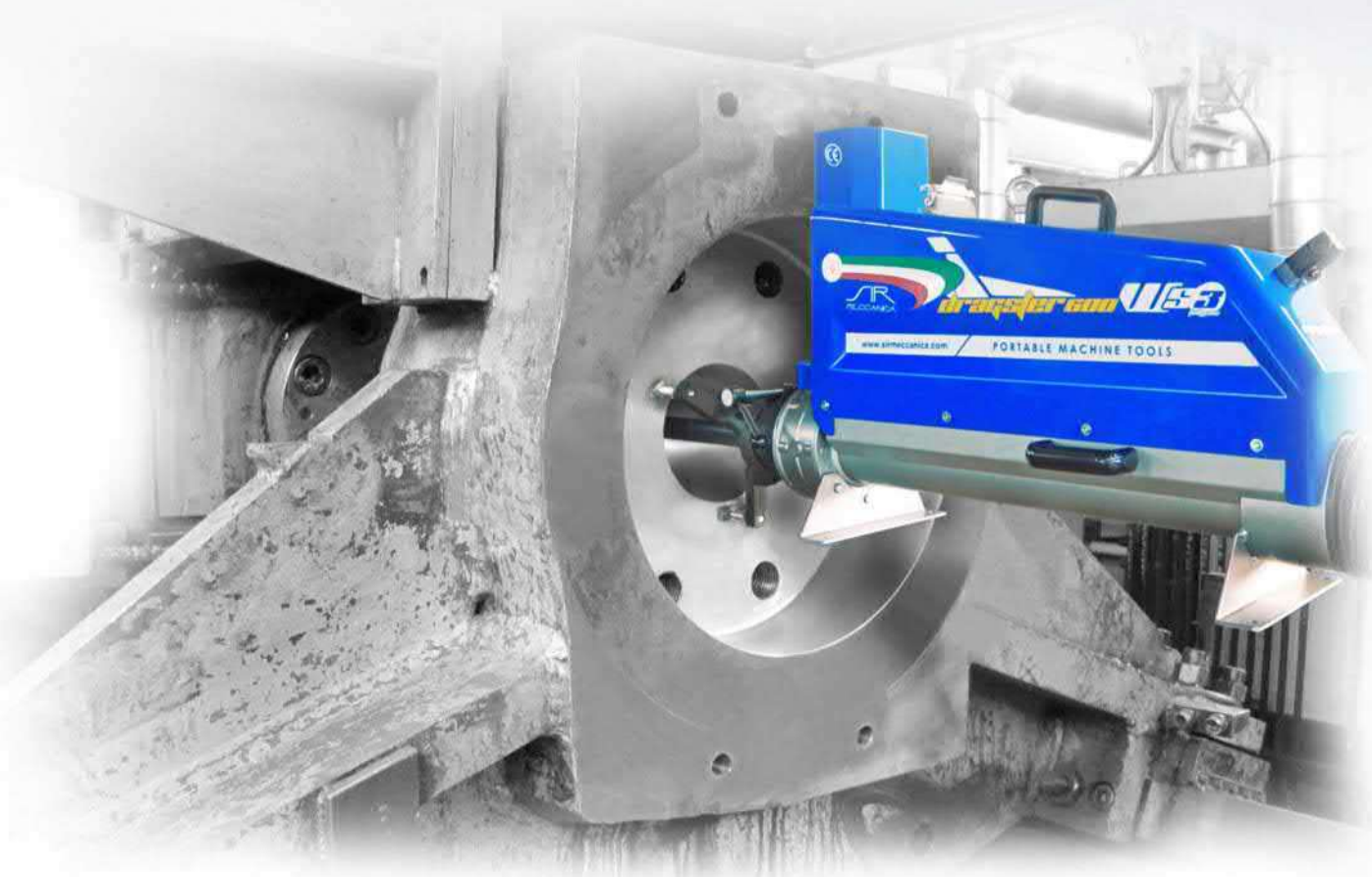



Series

dragster 800 FULL CNC

In-Line Boring and Overlay Welding Machine Tool ...hi Tech

The machine allows you to manage all the boring and CNC precise turning operations:

- Curved shaping with any tips of radius
- Conical machining and any type of chamfer
- All types of threadings
- Simple and shaped facing
- Any type of grooving
- Phonographic grooves



Technical Characteristic

WORKING DIAMETER	AXIAL STROKE (Z)	RADIAL STROKE (X)
110 mm - 600 mm	800 mm	It depends on the chosen model of machining head
3 DEGREE OF FREEDOM	2 AXIS	DRIVE UNIT WEIGHT
(X - Z - S)	(X - Z)	105 Kg

CUSTOMIZABLE according to customer's needs

Upon request the machine can also be supplied with the standard equipment to perform all the jobs carried by the **W Series, including the Overlay Welding**





dragster 1000

FULL CNC

In-Line Boring and Overlay Welding Machine Tool ...hi Tech

The machine allows you to manage all the boring and CNC precise turning operations:

- Curved shaping with any tips of radius
- Conical machining and any type of chamfer
- All types of threadings
- Simple and shaped facing
- Any type of grooving
- Phonographic grooves



Technical Characteristic

WORKING DIAMETER	AXIAL STROKE (Z)	RADIAL STROKE (X)
110 mm - 600 mm	1000 mm	It depends on the chosen model of machining head
3 DEGREE OF FREEDOM	2 AXIS	DRIVE UNIT WEIGHT
(X - Z - S)	(X - Z)	115,5 Kg
CUSTOMIZABLE according to customer's needs		

Upon request the machine can also be supplied with the standard equipment to perform all the jobs carried by the **W Series, including the Overlay Welding**





Fmax

Portable Universal Facing lathe/milling machine tool

For general flange facing, milling, boring, drilling (electronic dividing head for circular series) operations, creating of circular pockets, tapping, grooving, plunging, preparation of chamfers, overlay welding, oxygen cutting.



FMax 800



FMax 1500



FMax 2000 CNC



FMax 3000



FMax 4000



FMax 6000



PORTABLE UNIVERSAL FACING LATHE/MILLING MACHINE TOOL

New-concept machines entirely controlled by an electronic controller capable of performing the most diverse machining jobs on the faces of large cylindrical tubing, achieving unprecedented finish and accuracy results.

F-Max overcomes all technical/structural and vibration-related issues thanks to the simplicity with which it can be quickly installed on site; the lightweight for easy handling and to the multi-functionality.

Perfect inertia balancing permits operation in any position: horizontal, vertical and inclined. Its innovative construction compensates for radial and axial stress and tilting moment, minimizing harmful vibration.

F-Max may also be used as a precision drilling/tapping machine. Once the diameter and number of holes to be drilled has been set, the electronic controller automatically determines all drilling positions like an electronic indexing head.

Carries out operations of:

- GENERAL FLANGE FACING
- MILLING
- TAPPING
- BORING
- DRILLING (ELECTRONIC DIVIDING HEAD FOR CIRCULAR SERIES) OPERATIONS
- CREATING OF CIRCULAR POCKETS
- GROOVING
- PLUNGING
- BEVELING
- OVERLAY WELDING
- OXYGEN CUTTING



Electronic Control Panel

Designed to guarantee the maximum reliability and ergonomics, the Fmax Controller combines design and handiness in one solution. The control panel is adjustable in height and inclination according to the operator's needs, granting the maximum comfort for maneuverability and legibility.

There are 4 areas of control, one for each movement of the machine:

- [S] – milling rotation.
- [R] – machine rotation.
- [X] – radial feed.
- [Z] – axial feed.

For each movement, it is possible to set the direction and speed independently. All the speeds, those of translation [mm/min] as well as of rotation [rpm], are continuously monitored in an independent way. The translations are manageable through the “**Fast Feed Switch**”, and for each one, there is a **STATUS** display for the diagnostics of the functioning status. Each control area, is supplied with an **S.T.P** led bar, thanks to which it is possible to verify the current working load. When the **S.T.P** led bar flashes, it warns the operator that the machine is overloaded, giving the possibility to modify the cutting parameters properly.

In the version with **the electronic divider/positioner** for circular series of holes, the controller is equipped with an additional alphanumeric **LCD display**, 3 more switches and a signal led tower. By indicating the number of holes and the diameter on which they need to be equally distributed, this optional accessory, positions the machine on the exact coordinates on which each hole will have to be placed;

The alternate switching of the 3 colors, along with the acoustic signals, continuously guides and updates the operators, who are far away from the controller, on the working status in progress.



Fmax 800

PORTABLE UNIVERSAL FACING LATHE/MILLING MACHINE TOOL

The **Fmax**, has been created to carry out operations such as facing, internal and external beveling, the creation of concentric and/or spiral cylindrical shape grooves, as well as the preparation of edges and chamfers for welding.

Applications:

- **MILLING**
- **TURNING OPERATIONS**
- **CONTOURING**

FMax 800 has been created to perform operations such as:

- Facing
- Internal and external beveling
- Creation of concentric and/or spiral cylindrical shape grooves
- As well as preparation of edges and chamfers for welding



DIAMETER OF FACING	CENTRING AXIS DIAMETER	TOOL HOLDER ARM
350 mm - 800 mm	50 mm	600 mm
RADIAL STROKE	AXIAL STROKE	HEAD ROTATION (ROLL)
180 mm	40 mm	360°

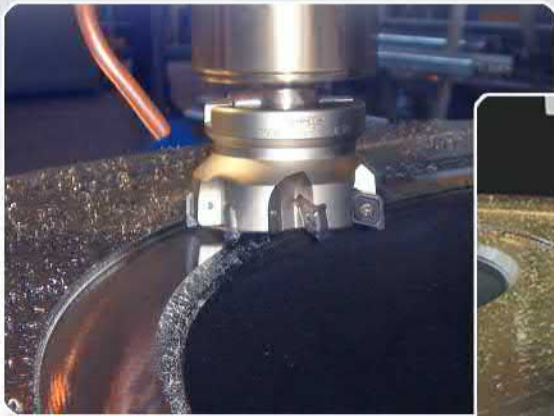

SR
MECCANICA

Fabbrica Italiana Macchine Utensili Portatili Multifunzione

Fmax 1500

PORTABLE UNIVERSAL FACING LATHE/MILLING MACHINE TOOL

The **Fmax**, has been created to carry out operations such as facing, internal and external beveling, the creation of concentric and/or spiral cylindrical shape grooves, as well as the preparation of edges and chamfers for welding.

Applications:

- MILLING
- CONTOURING
- CALIBRATED DRILLING ON CIRCULAR SERIES
- TAPPING ON CIRCULAR SERIES
- CREATION OF CIRCULAR POCKETS
- CIRCULAR MIG WELDING
- CIRCULAR OXYGEN CUTTING



DIAMETER OF FACING	WELDING DIAMETER	DRILLING DIAMETER	HEAD ROTATION (PITCH)
400 mm -1700 mm	400 mm -1700 mm	12 mm - 100 mm	360°
TAPPING DIAMETER	CENTRING AXIS DIAMETER	AXIAL STROKE	RADIAL STROKE
M2 - M30	100 mm	150 mm	400 mm



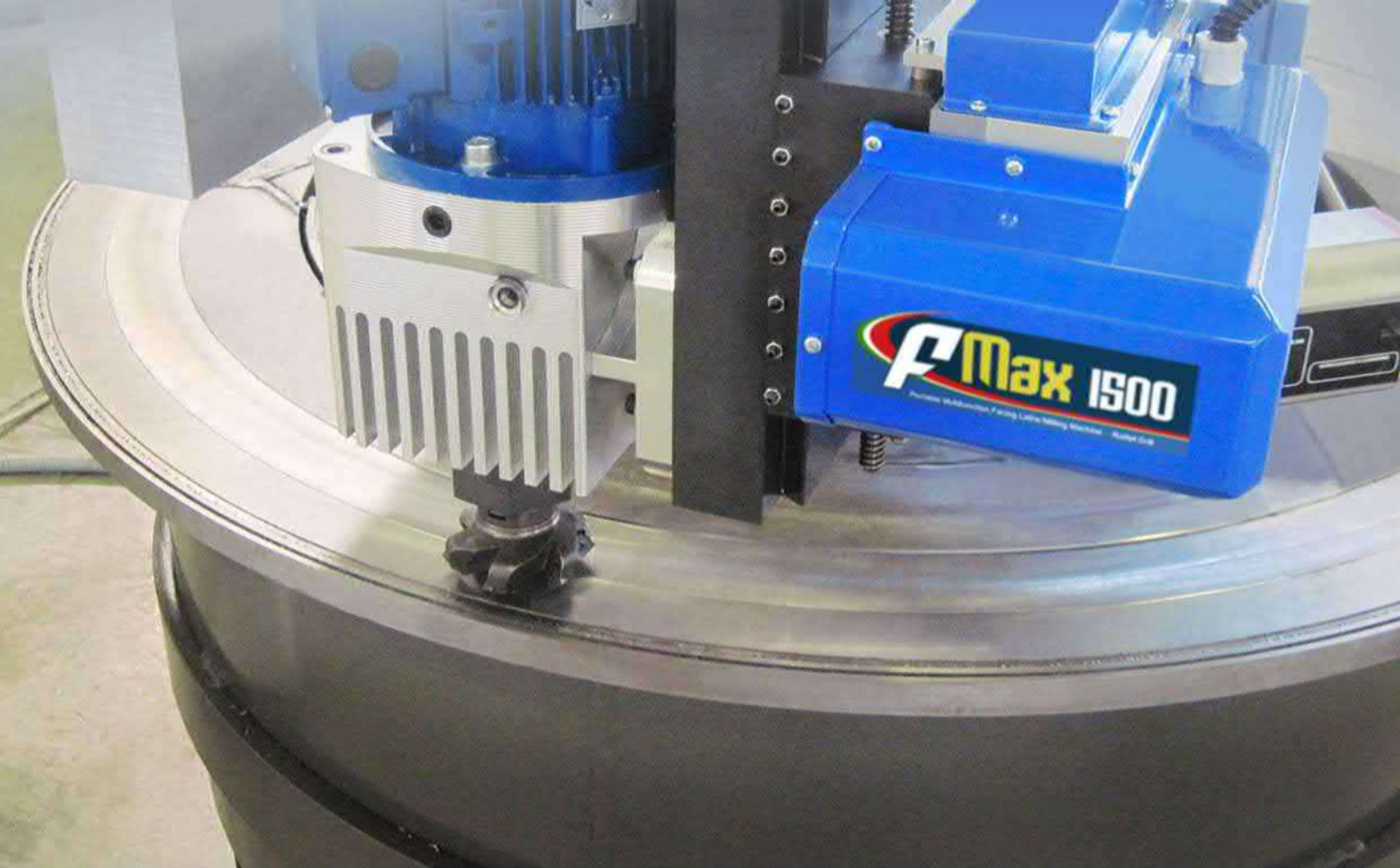

SIR
MECCANICA

Fabbrica Italiana Macchine Utensili Portatili Multifunzione

Fmax 2000 Cnc

PORTABLE UNIVERSAL FACING LATHE/MILLING MACHINE TOOL

CNC multi-function portable machine tool – universal 3-axis rotating milling machine; Technologically advanced machines, programmable/computerized, able to carry out work cycles in a completely autonomous way and with micrometric precision.

Applications:

- Milling
- Contouring
- Calibrated drilling on circular series
- Tapping on circular series
- Creation of circular pockets
- Circular mig welding
- Circular oxygen cutting



Technical Characteristics:

- Milling/Drilling with 3 degree of freedom (X,Z,S).
- Movement on prismatic guides.
- Traversing through recirculating ball screws.
- Modular clamping from 405mm \times 2000mm[diameter].
- Machine's body with configurable axial positioning.
- Machine axis D = 150 [mm] L=1200 [mm] (customizable).
- Minimum machining diameter (milling cutter center) = 500 [mm] approx.
- Maximum machining diameter (milling cutter center) =2000 [mm] approx.
- Adjustable counterweight.
- Arms with configurable radial positioning L=1200 (customizable).
- Maximum radial stroke = 700 [mm] approx.
- Configurable and reversible positioning of milling head: axially (H= 150 mm), angularly (A = 360°).
- Milling cutter with coupling taper ISO 40.
- Maximum axial stroke = 150 [mm] approx.
- Hand wheel manual position axes X e Z.



SR
MECCANICA

Fabbrica Italiana Macchine Utensili Portatili Multifunzione

Fmax 3000

PORTABLE UNIVERSAL FACING LATHE/MILLING MACHINE TOOL

The Fmax, has been created to carry out operations such as facing, internal and external beveling, the creation of concentric and/or spiral cylindrical shape grooves, as well as the preparation of edges and chamfers for welding.

Applications:

- MILLING
- CONTOURING
- CALIBRATED DRILLING ON CIRCULAR SERIES
- TAPPING ON CIRCULAR SERIES
- CREATION OF CIRCULAR POCKETS
- CIRCULAR MIG WELDING
- CIRCULAR OXYGEN CUTTING



DIAMETER OF FACING	WELDING DIAMETER	DRILLING DIAMETER	HEAD ROTATION
1000 mm - 3000 mm	1000 mm - 3000 mm	12 mm - 100 mm	Roll 360° - Pitch -45°+20°
TAPPING DIAMETER	MOD CENTRING FASTEN & SUPP.	AXIAL STROKE	RADIAL STROKE
M2 - M30	800 mm - 3000 mm	200 mm	250 mm





SR
MECCANICA

Fabbrica Italiana Macchine Utensili Portatili Multifunzione

Fmax 4000

PORTABLE UNIVERSAL FACING LATHE/MILLING MACHINE TOOL

The **Fmax**, has been created to carry out operations such as facing, internal and external beveling, the creation of concentric and/or spiral cylindrical shape grooves, as well as the preparation of edges and chamfers for welding.

Applications:

- MILLING
- CONTOURING
- CALIBRATED DRILLING ON CIRCULAR SERIES
- TAPPING ON CIRCULAR SERIES
- CREATION OF CIRCULAR POCKETS
- CIRCULAR MIG WELDING
- CIRCULAR OXYGEN CUTTING

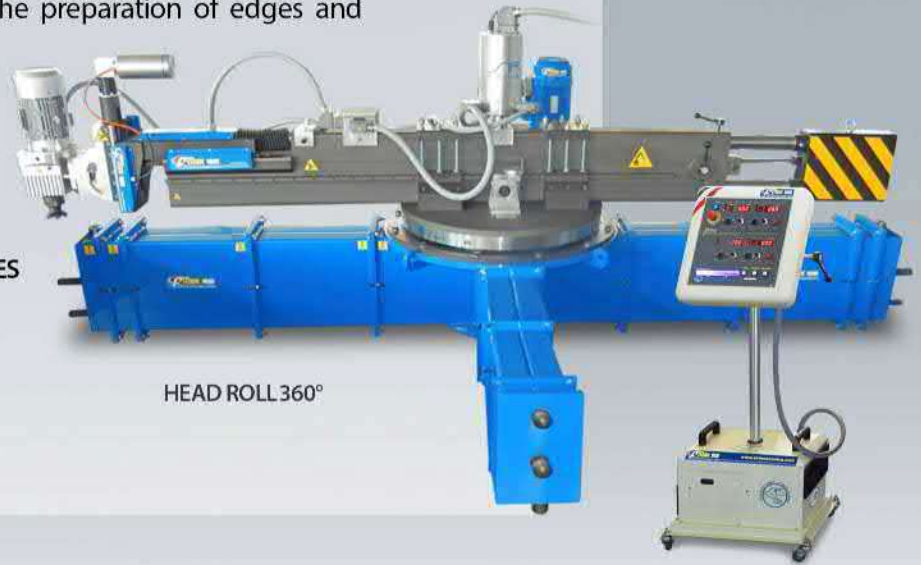

DIAMETER OF FACING	WELDING DIAMETER	DRILLING DIAMETER	HEAD ROTATION
1500 mm - 4700 mm	1500 mm - 4700 mm	12 mm - 100 mm	Roll 360° - Pitch -45°+20°
TAPPING DIAMETER	MOD CENTRING FASTEN & SUPP.	AXIAL STROKE	RADIAL STROKE
M2 - M30	1400 mm - 4700 mm	200 mm	250 mm



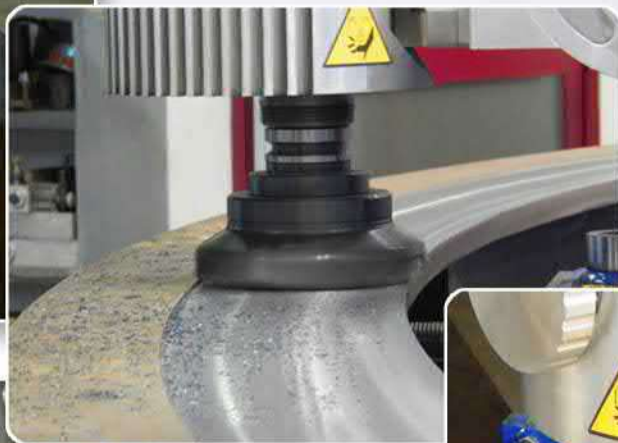

SR
MECCANICA

Fabbrica Italiana Macchine Utensili Portatili Multifunzione

Fmax 6000

PORTABLE UNIVERSAL FACING LATHE/MILLING MACHINE TOOL

The Fmax, has been created to carry out operations such as facing, internal and external beveling, the creation of concentric and/or spiral cylindrical shape grooves, as well as the preparation of edges and chamfers for welding.

Applications:

- MILLING
- CONTOURING
- CALIBRATED DRILLING ON CIRCULAR SERIES
- TAPPING ON CIRCULAR SERIES
- CREATION OF CIRCULAR POCKETS
- CIRCULAR MIG WELDING
- CIRCULAR OXYGEN CUTTING



DIAMETER OF FACING	WELDING DIAMETER	DRILLING DIAMETER	HEAD ROTATION
1900 mm - 6000 mm	1900 mm - 6000 mm	12 mm - 100 mm	ROLL 360° PITCH -45° + 20°
TAPPING DIAMETER	MOD CENTRING FASTEN & SUPP.	AXIAL STROKE	RADIAL STROKE
M2 - M30	1800 mm - 6000 mm	200 mm	250 mm



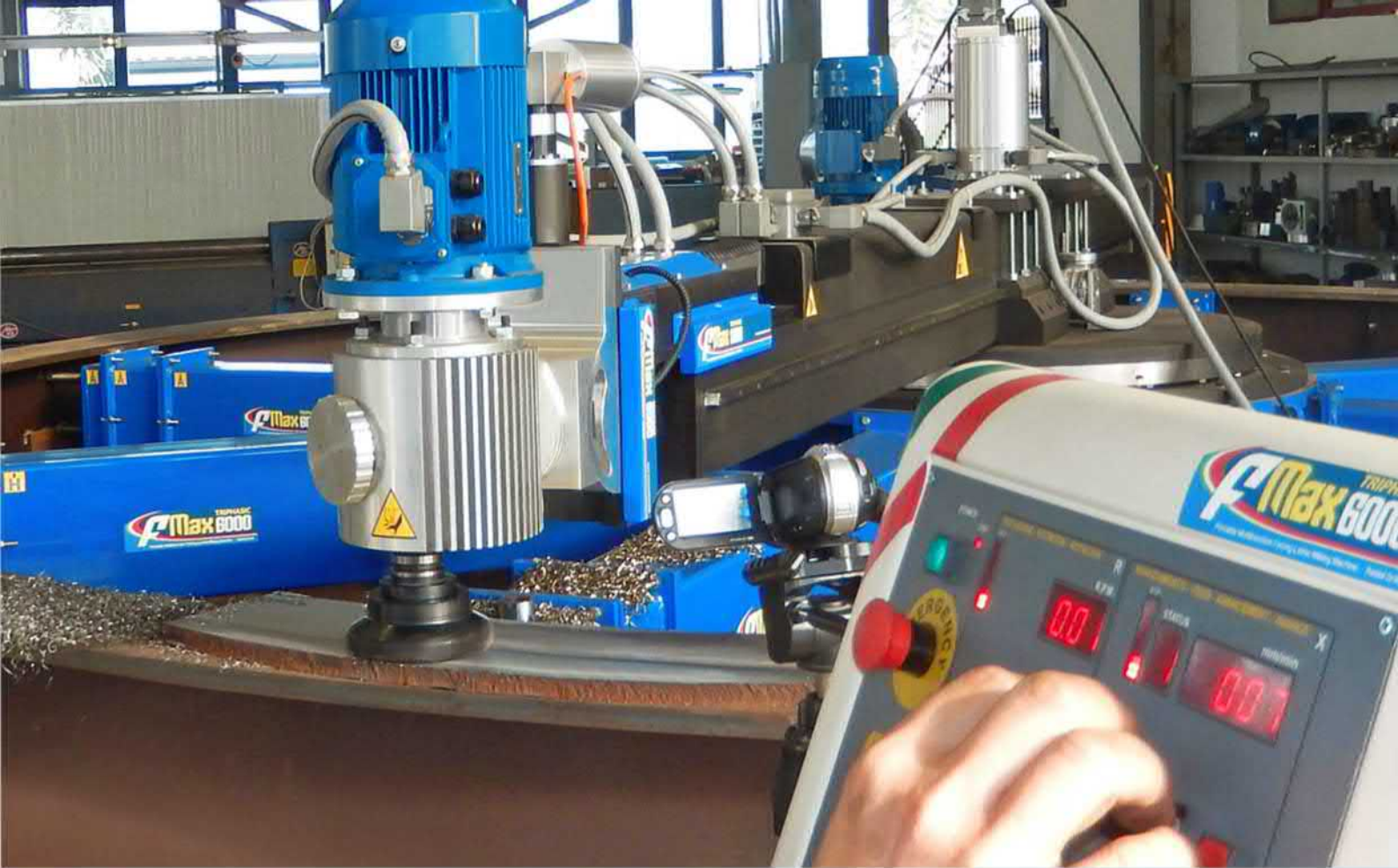

SR
MECCANICA

Fabbrica Italiana Macchine Utensili Portatili Multifunzione



Portable Universal Facing lathe/milling Machine Tool

ACCESSORY KIT

Accessories and kits to add on each single machine, in order to enhance or modify the operation possibilities.





• **Turning Kit**
(Only for FMax 800)



• **Drilling Kit**



• **Boring Kit**



• **Circular Pocket Kit**



• **Tapping Kit**



• **Welding Kit**



• **Oxygen Cutting Kit**



• **Electronic Indexing Head**

TOP Series

Full CNC Portable Orbital Lathe

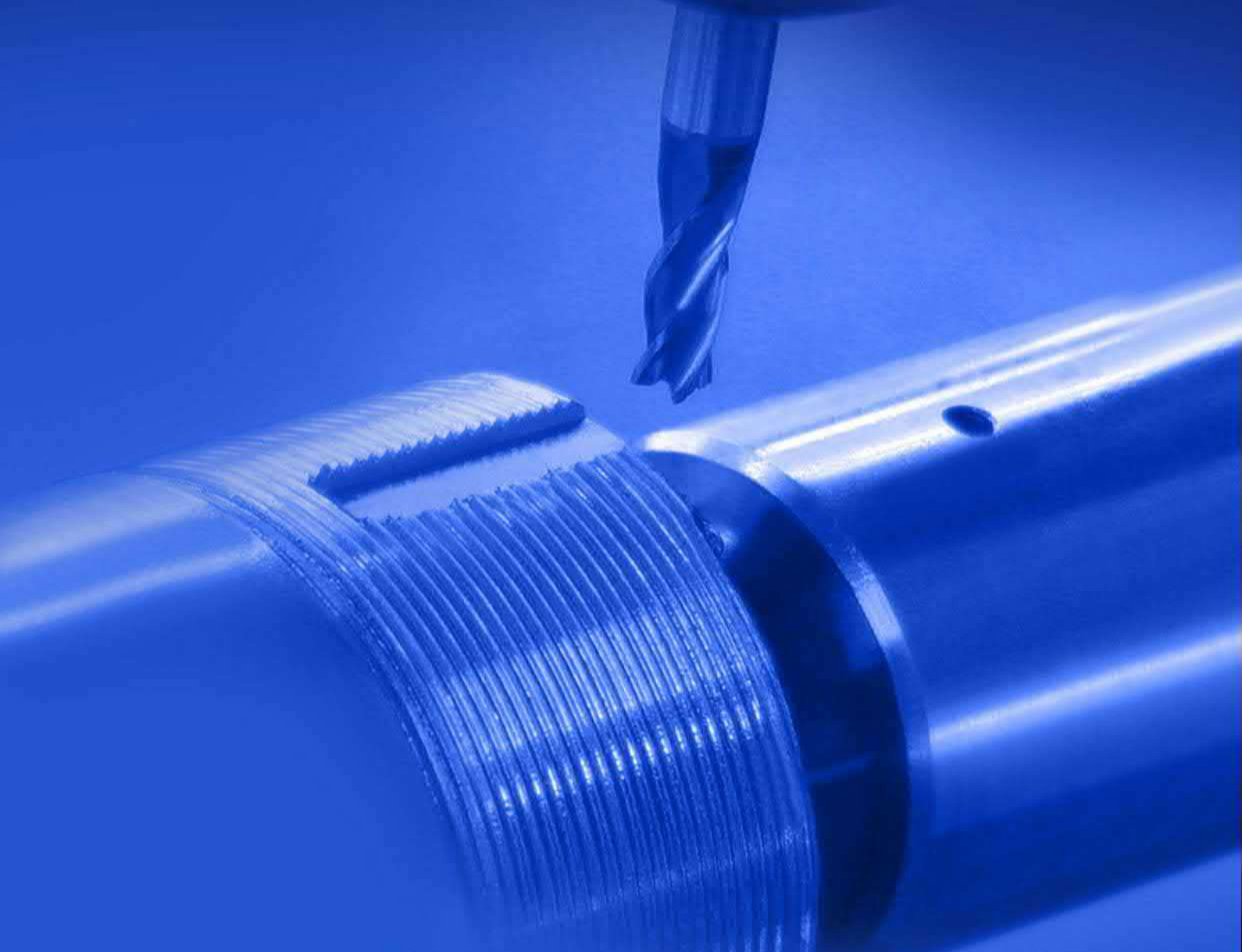

For "on-site" turning with extreme precision (completely run by a CNC control panel), on faces and internal and/or external extremities of cylindrical surfaces, of fixed tubular bodies which are immovable or impossible to rotate.

- RECTILINEAR AND/OR CURVED – INTERNAL AND/OR EXTERNAL INTERPOLATIONS
- STANDARD AND/OR TAPERED THREADING
- SIMPLE AND/OR PROFILE FACING
- MULTILEVEL CYLINDRICAL GROOVES



Top 200



Top 400



TOUCH SCREEN DISPLAY

The CNC interface is simple and intuitive. Besides the possibility to create programs manually, it is also possible to execute files created by sophisticated **CAM** programs without having to key in any command.

The three modalities **FILE**, **JOG** e **MDI** are fully supported and can be used together. It is possible to open a file and view it, give commands in **MDI modality** and pass onto the **JOG modality** without any limits.

TOP 200

Full CNC Portable Orbital Lathe

Created for machining on faces and on internal and external surfaces of fixed tubular bodies that are impossible to rotate and are not accessible by conventional machine tools.

Suitable for the most various, complex and precise turning operations:

- Rectilinear and /or curved profiles and interpolations.
- Multilevel grooves.
- Standard and/or tapered threading.
- Shaped facing.



Technical Characteristics

RADIAL STROKE (X)	AXIAL STROKE (Z)	MAX WORKING DIAMETER
50 mm	100 mm	200 mm
MAX ROTATION SPEED (S)	3 DEGREE OF FREEDOM	2 AXIS
210 Rpm	(X - Z - S)	(X - Z)
DRIVE UNIT WEIGHT		
56 Kg		



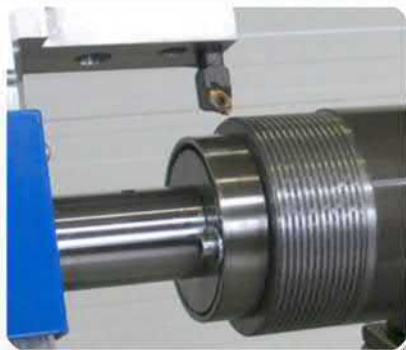

SIR
MECCANICA

Fabbrica Italiana Macchine Utensili Portatili Multifunzione

TOP 400

Full CNC Portable Orbital Lathe

Created for machining on faces and on internal and external surfaces of fixed tubular bodies that are impossible to rotate and are not accessible by conventional machine tools.

Suitable for the most various, complex and precise turning operations:

- Rectilinear and /or curved profiles and interpolations.
- Multilevel grooves.
- Standard and/or tapered threading.
- Shaped facing.



Technical Characteristics

RADIAL STROKE (X)	AXIAL STROKE (Z)	MAX WORKING DIAMETER
80 mm	200 (Long Version 320)	400 mm
MAX ROTATION SPEED (S)	3 DEGREE OF FREEDOM	2 AXIS
143 Rpm	(X - Z - S)	(X - Z)
DRIVE UNIT WEIGHT		
115 Kg		



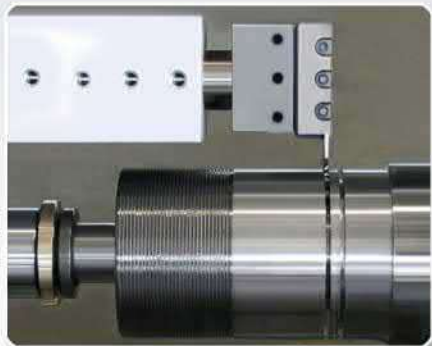

SR
MECCANICA

Fabbrica Italiana Macchine Utensili Portatili Multifunzione



WTMAX Series
PORTABLE THREADING MACHINE TOOL

Portable Threading Machine Tool/ WTMAX



W TMAX

WTMAX Series

PORTABLE THREADING MACHINE TOOL

The WTMax is an electronically operated portable machine tool for the creation of internal cylindrical threading.

WTMax will create different threads.

The threading diameters and the longitudinal stroke of the machine can also be customized.



Technical Characteristics

TOOL HOLDER SHAFT DIAMETER	TOOL HOLDER SHAFT LENGTH	FEED SYSTEM
60 mm	1500 mm	MECHANICAL (type and pitch of threading on request)
LONGITUDINAL STROKE	MAXIMUM TORQUE OF THE SHAFT	MAXIMUM THREADING SPEED
350 mm	850 Nm	11 Rpm
DRIVE UNIT WEIGHT		
50 Kg		

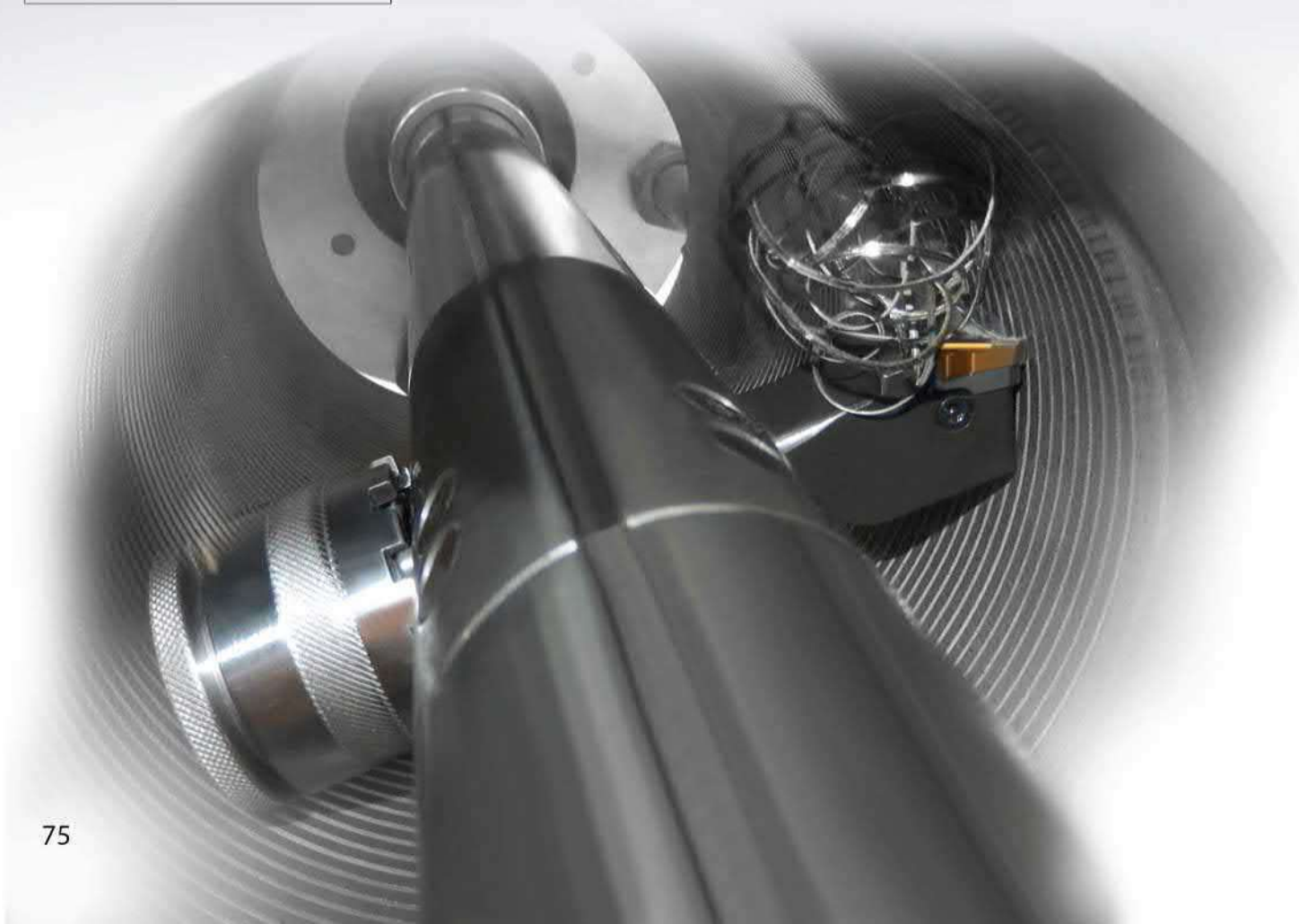

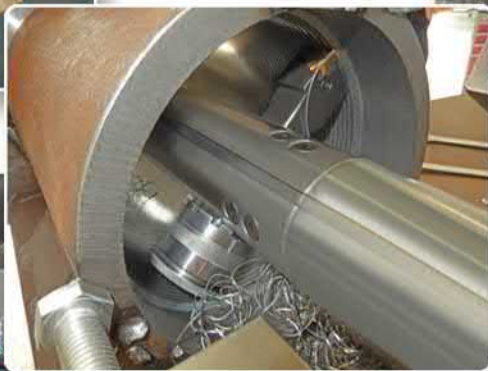

SR
MECCANICA

Fabbrica Italiana Macchine Utensili Portatili Multifunzione

RS X⁹ Series

Boring Machine with fixed axle shaft

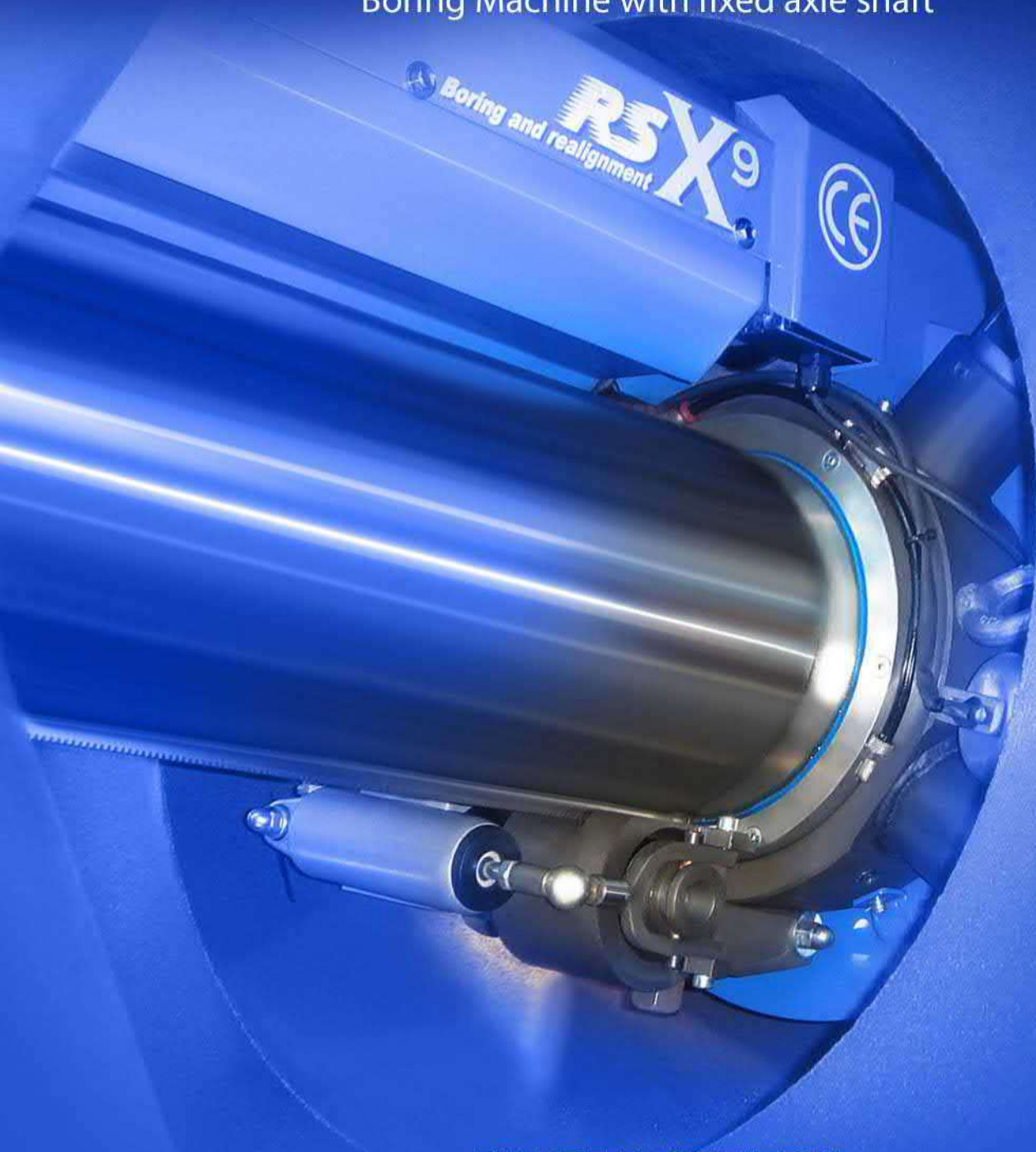

THE IDEAL SOLUTION
FOR BORING AND REALIGNMENT ON BIG DIAMETERS
AND OVER LONG LENGTHS



The **RSX9** is a portable electronic precision boring machine for large bodies with long cylindrical bores not accessible to conventional machines. It performs on site grinding jobs and alignment on large bodies for indefinite lengths. Through the use of the appropriate accessories it performs facing on frontal cavities. It can satisfy the highest quality standards, both in terms of geometric tolerances and surface finish, it is adaptable and flexible for any application.

RSX⁹ Series

Boring Machine with fixed axle shaft

The ideal solution for boring and realignment on big diameters and over long lengths.

- BORING
- REALIGNMENT ON BIG DIAMETERS AND OVER LONG LENGTHS



Technical Characteristics RSX9 800 - RSX9 1200

DIAMETER OF CENTRAL FIXED AXLE SHAFT	LENGTH OF CENTRAL FIXED AXLE SHAFT	BORING DIAMETER
180 mm	6000 mm	500 - 800 mm (RSX9 800) 700 - 1200 mm (RSX9 1200)
MAX TORQUE OF ROTATION TOOL	MAX FEED SPEED	MAX ROTATION SPEED
1800 Nm (RSX9 800) - 5000 Nm (RSX9 1200)	200 mm/min	55 Rpm (RSX9 800) - 30 Rpm (RSX9 1200)
DRIVE UNIT WEIGHT		
58 Kg (RSX9 800) - 65 Kg (RSX9 1200)		

The **RSX9**, for the precise and solid mechanical structure, is suitable for all the numerous turning applications of roughing and finishing of internal cylindrical surfaces.



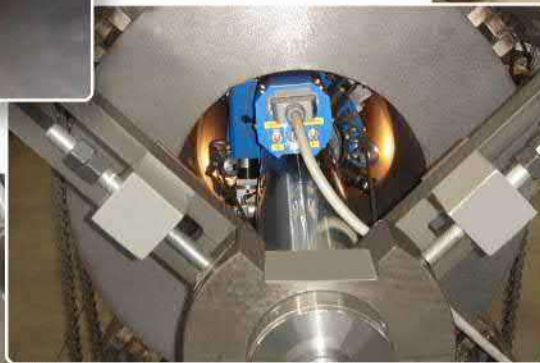
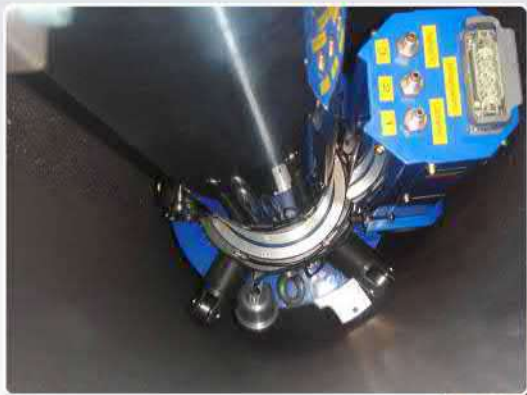
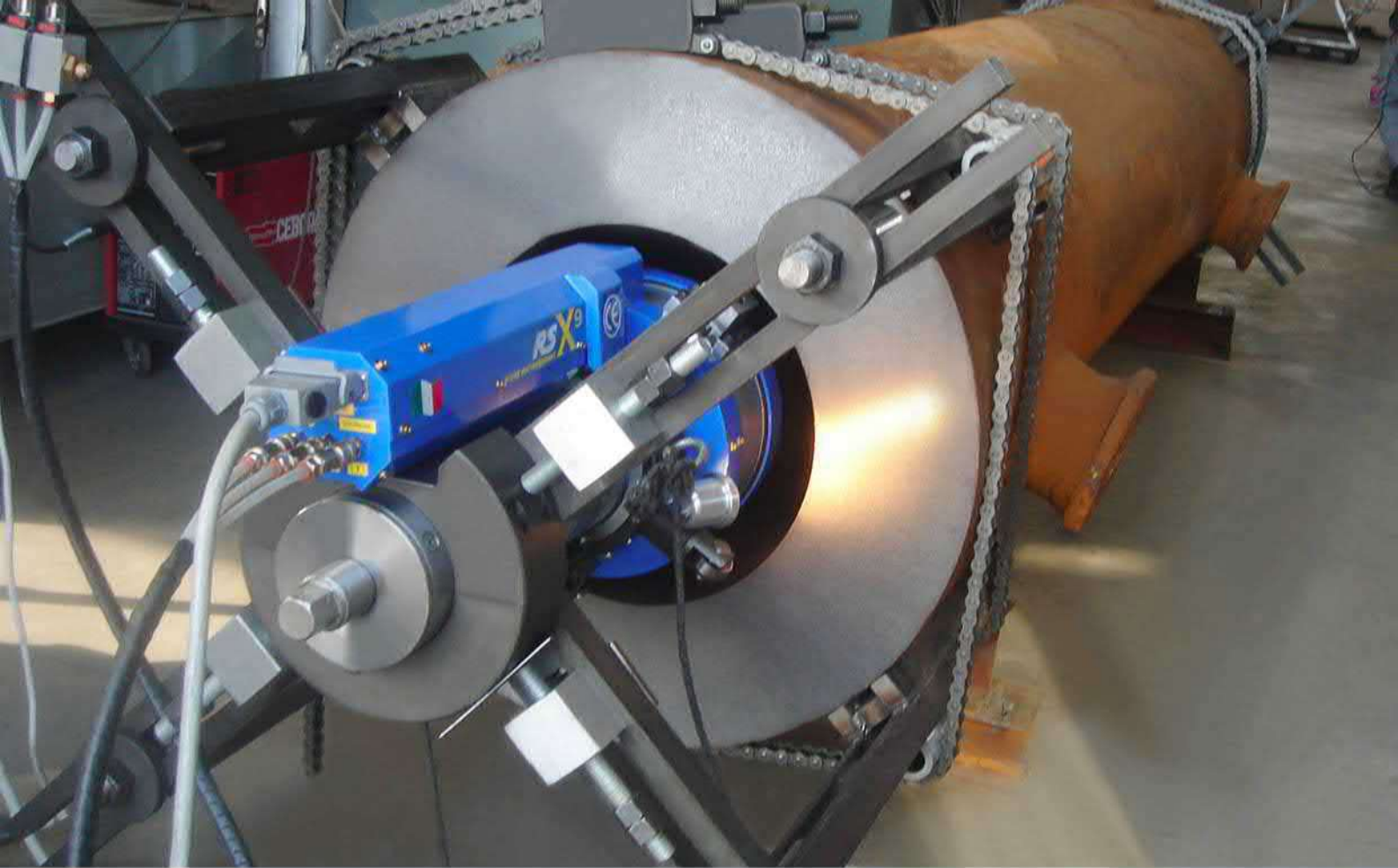

SR
MECCANICA

Fabbrica Italiana Macchine Utensili Portatili Multifunzione

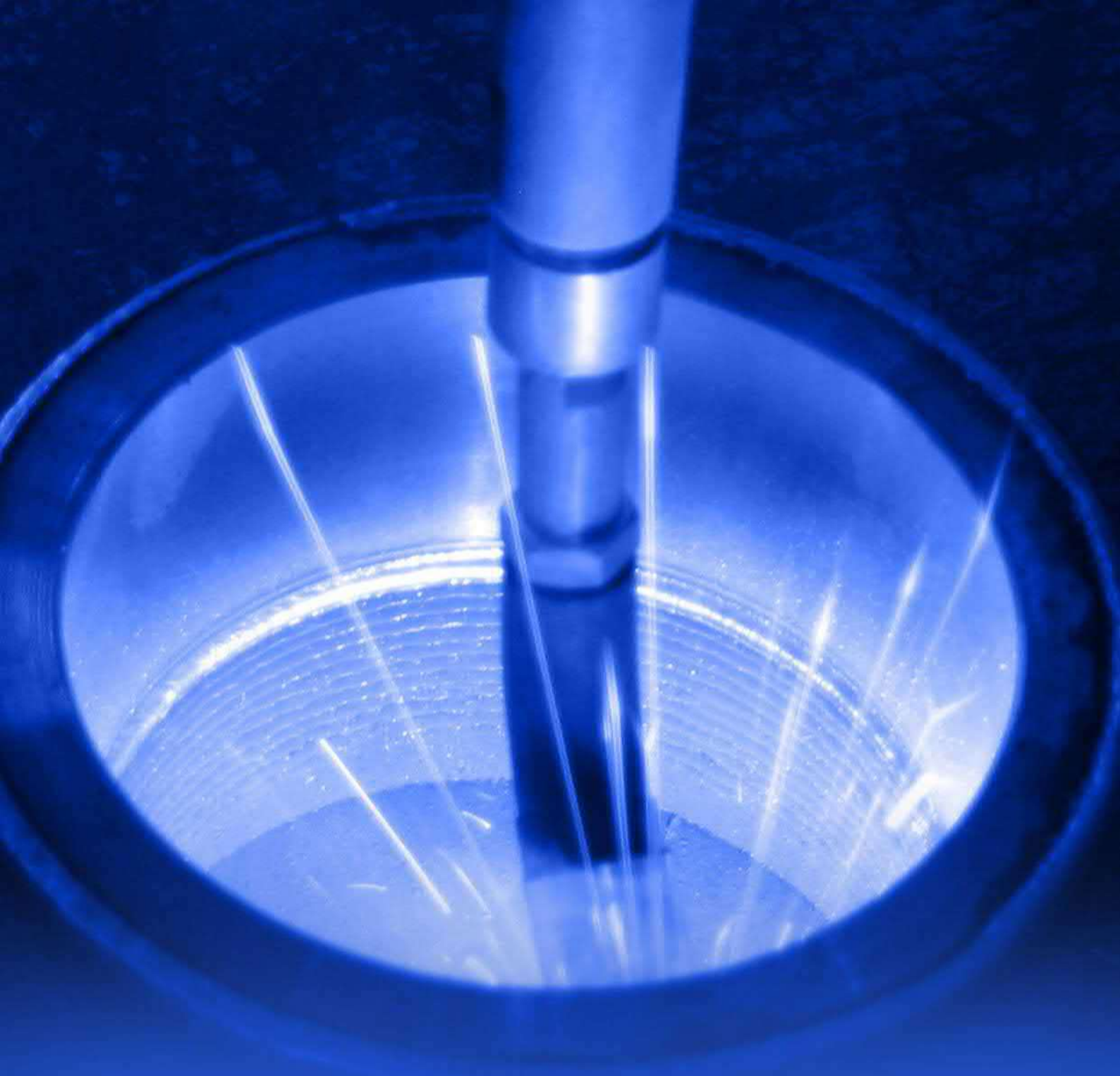

Rotary Welding

Internal and External Overlay Welding



RW 2014



Rotary Welding

The best solution for External Overlay Welding.



Technical Characteristics

WELDING DIAMETER	GEAR TRANSMISSION	SPEED
50 mm - 550 mm	On a timing belt	8,5 Rpm
MAX ABSORBMENT	MAXIMUM TORQUE	WEIGHT
0,6 A (7,2W)	300 Nm	20 Kg

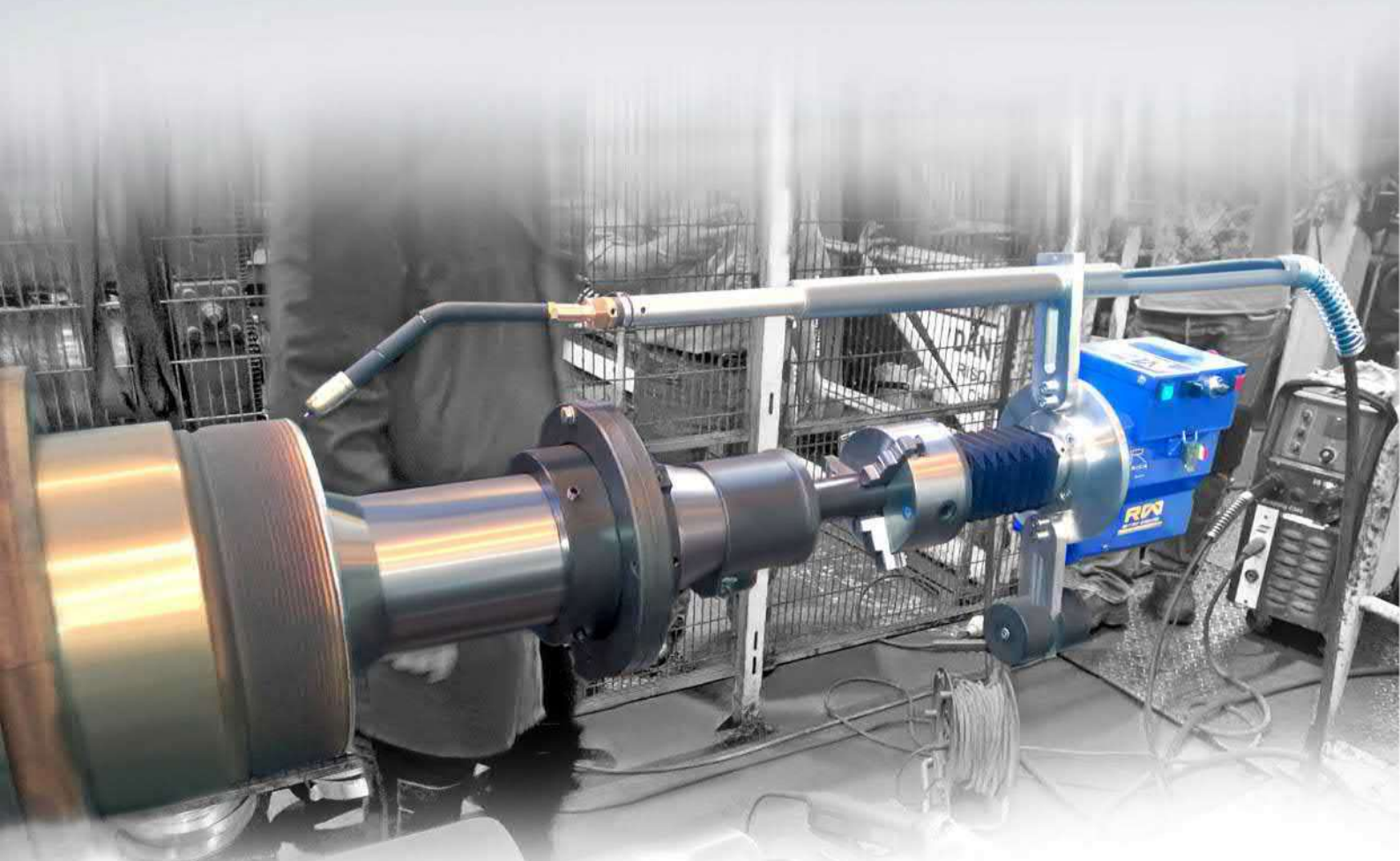

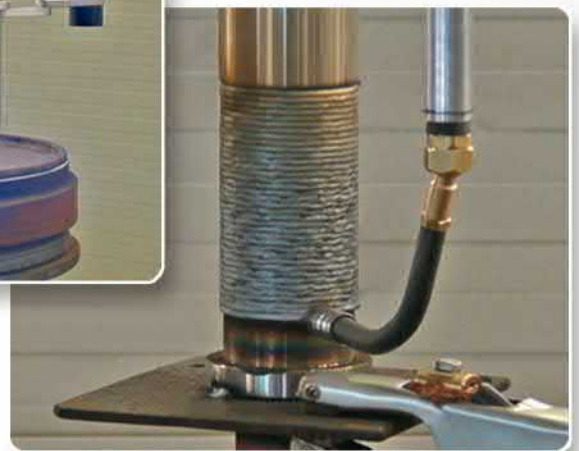

SR
MECCANICA

Fabbrica Italiana Macchine Utensili Portatili Multifunzione

Rotary Welding

External and Internal Overlay Welding



Technical Characteristic

WELDING DIAMETER	WELDING TECHNOLOGY	LONGITUDINAL STROKE
25 mm - 400 mm	SPIRAL (CONTINUOUS)	UNLIMITED WITH STEP OF 220 mm
FEED SYSTEM	MAX ROTATION SPEED	
ELECTRIC-MECHANICAL	44 Rpm	
MOTOR	DRIVE UNIT WEIGHT	
45 W	8 kg	





SR
MECCANICA

Fabbrica Italiana Macchine Utensili Portatili Multifunzione

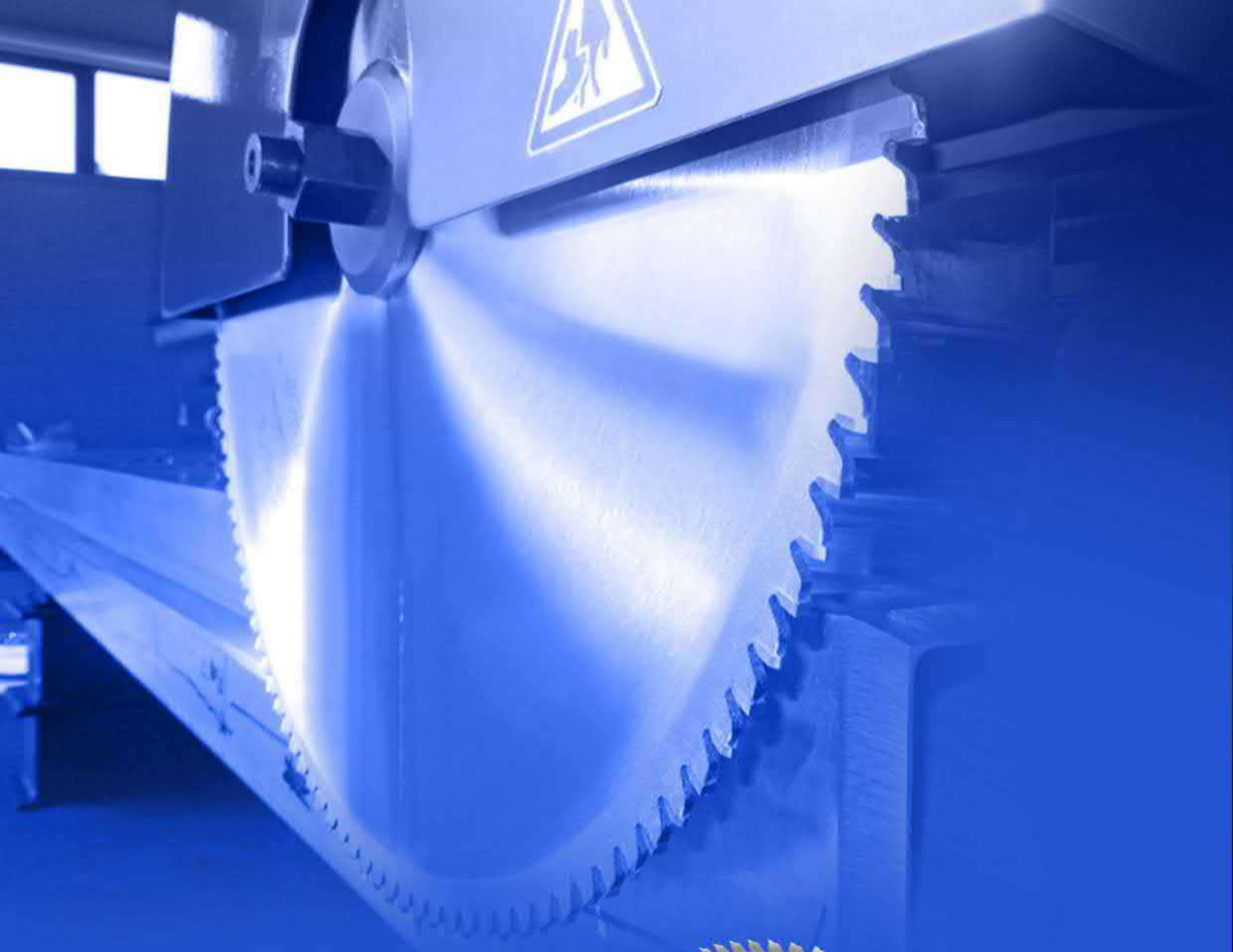

SM500 Series

Linear Cutting Machine



The machine has a motorized movement and it is electronically controlled on 3 degrees of freedom, for the remaining 3 it is manual and not motorized:

1. Axial translation Z (motorized).
2. Rectilinear translation X (motorized).
3. Rectilinear translation Y (manual).
4. Longitudinal translation L (manual).
5. Rotation S (motorized -blade rotation).
6. Rotation R (machine rotation).



Semi-automatic – the cutting movements are entirely controlled by the control panel created to perform cutting operations on surfaces surrounding the machine.

It is portable, designed to perform “on-site” machining operations equipped with rapid movements to optimize working times. It can be installed on horizontal, vertical or any position surfaces.





Viale Europa 37, 88100 Catanzaro - (Italy)

Phone: +39 0961 769696 - 769734 - 769672 - Fax: +39 0961-368712

Web Site: www.sirmeccanica.com

E-mail: sirmecc@sirmeccanica.com